

JEFFERSON MATH PROJECT

REGENTS BY CHAPTER

All 1530 NY Math A & B Regents Exam Questions from
June 1999 to June 2007 Sorted by Prentice Hall Chapter
GEOMETRY

www.jmap.org



Dear Sir

I have to acknowledge the receipt of your favor of May 14. in which you mention that you have finished the 6. first books of Euclid, plane trigonometry, surveying & algebra and ask whether I think a further pursuit of that branch of science would be useful to you. there are some propositions in the latter books of Euclid, & some of Archimedes, which are useful, & I have no doubt you have been made acquainted with them. trigonometry, so far as this, is most valuable to every man, there is scarcely a day in which he will not resort to it for some of the purposes of common life. the science of calculation also is indispensable as far as the extraction of the square & cube roots; Algebra as far as the quadratic equation & the use of logarithms are often of value in ordinary cases: but all beyond these is but a luxury; a delicious luxury indeed; but not to be indulged in by one who is to have a profession to follow for his subsistence. in this light I view the conic sections, curves of the higher orders, perhaps even spherical trigonometry, Algebraical operations beyond the 2d dimension, and fluxions.

Letter from Thomas Jefferson to William G. Munford, Monticello, June 18, 1799.

TABLE OF CONTENTS

GEOMETRY

	<u>PRENTICE HALL CHAPTER</u>	<u>QUESTION NUMBER</u>
CH1	Tools of Geometry	1-16
CH2	Investigating Geometric Figures	17-50
CH3	Transformations: Shapes in Motion	51-126
CH4	Triangle Relationships	127-207
CH5	Measuring in the Plane	208-273
CH6	Measuring in Space	274-297
CH7	Reasoning and Parallel Lines	298-308
CH8	Proving Triangles Congruent	309-316
CH9	Quadrilaterals	317-334
CH10	Similarity	335-350
CH11	Right Triangle Geometry	351-363
CH12	Chords, Secants, and Tangents	364-397

CHAPTER 1-6

NY LESSON 3

CONSTRUCTIONS

1. In the accompanying diagram of a construction, what does \overline{PC} represent?

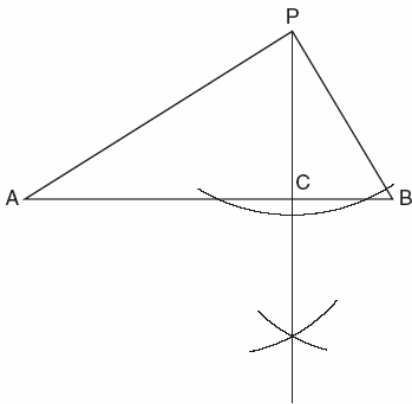

- [A] a median drawn to \overline{AB}
[B] the perpendicular bisector of \overline{AB}
[C] the bisector of $\angle APB$
[D] an altitude drawn to \overline{AB}
2. Using only a ruler and compass, construct the bisector of angle BAC in the accompanying diagram.

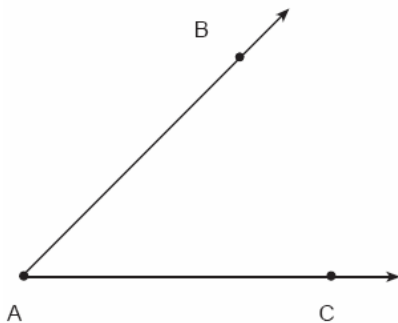

3. Using a compass and straightedge, construct the perpendicular bisector of \overline{AB} shown below. Show all construction marks.



4. Using only a compass and a straightedge, construct the perpendicular bisector of \overline{AB} and label it c . [Leave all construction marks.]

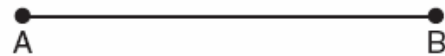

5. On the accompanying diagram of $\triangle ABC$, use a compass and a straightedge to construct a median from A to \overline{BC} .

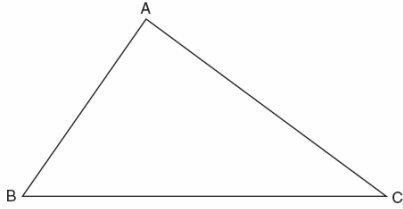

6. Construct a triangle with sides of lengths a , b , and c , as shown below. Be sure the longest side of your triangle lies on \overline{PQ} and that point P is one of the triangle's vertices. [Show all arcs necessary for a valid construction.]

a _____
 b _____
 c _____



8. In the accompanying diagram, \overline{AB} and \overline{CD} intersect at E . If $m\angle AEC = 4x - 40$ and $m\angle BED = x + 50$, find the number of degrees in $\angle AEC$.

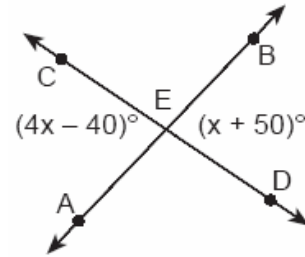

9. In the accompanying figure, two lines intersect, $m\angle 3 = 6t + 30$, and $m\angle 2 = 8t - 60$. Find the number of degrees in $m\angle 4$.

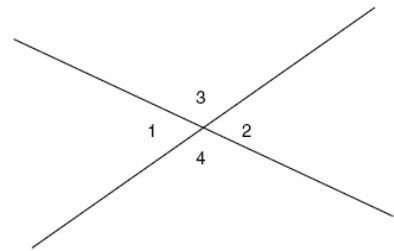

CHAPTER 1-7

COMPLEMENTARY SUPPLEMENTARY AND VERTICAL ANGLES

7. In the accompanying diagram, line a intersects line b .



What is the value of x ?

- [A] 10 [B] 90 [C] 5 [D] -10

10. \overline{AB} and \overline{CD} intersect at point E , $m\angle AEC = 6x + 20$, and $m\angle DEB = 10x$. What is the value of x ?

- [A] $21\frac{1}{4}$ [B] $4\frac{3}{8}$ [C] 5 [D] 10

11. \overline{AB} and \overline{CD} intersect at E . If $m\angle AEC = 5x - 20$ and $m\angle BED = x + 50$, find, in degrees, $m\angle CEB$.

12. If the measure of an angle is represented by $2x$, which expression represents the measure of its complement?

- [A] $88x$ [B] $90 + 2x$
 [C] $90 - 2x$ [D] $180 - 2x$

13. The measures of two complementary angles are represented by $(3x + 15)$ and $(2x - 10)$. What is the value of x ?
[A] 35 [B] 37 [C] 17 [D] 19
14. The ratio of two supplementary angles is 2:7. What is the measure of the *smaller* angle?
[A] 40° [B] 10° [C] 14° [D] 20°
15. The ratio of two supplementary angles is 3:6. What is the measure of the *smaller* angle?
[A] 20° [B] 60° [C] 30° [D] 10°
16. Two angles are complementary. One angle has a measure that is five times the measure of the other angle. What is the measure, in degrees, of the larger angle?

18. Triangle ABC , with side \overline{AC} extended to D , is shown in the accompanying diagram. If $m\angle ABC = 63$ and $m\angle BCD = 92$, what is $m\angle BAC$?

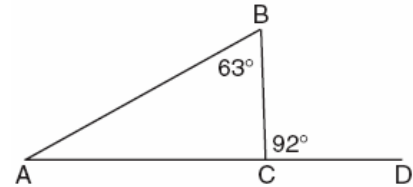

19. In the accompanying diagram, $\overline{AB} \parallel \overline{CD}$. From point E on \overline{AB} , transversals \overline{EF} and \overline{EG} are drawn, intersecting \overline{CD} at H and I , respectively.

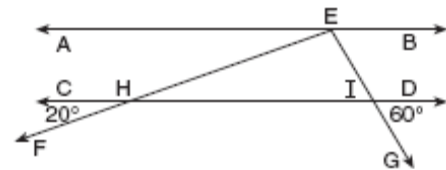

If $m\angle CHF = 20$ and $m\angle DIG = 60$, what is $m\angle HEI$?

- [A] 100 [B] 120 [C] 80 [D] 60

20. In the accompanying diagram of $\triangle BCD$, $m\angle C = 70$, $m\angle CDE = 130$, and side \overline{BD} is extended to A and to E . Find $m\angle CBA$.

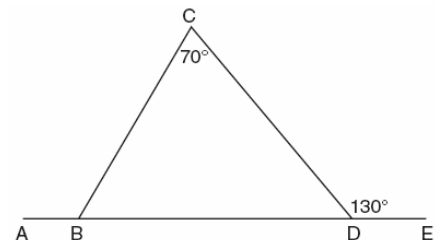

CHAPTER 2-1

INTERIOR AND EXTERIOR ANGLES OF TRIANGLES

17. In the accompanying diagram of $\triangle ABC$, \overline{AB} is extended to D , exterior angle CBD measures 145° , and $m\angle C = 75$.

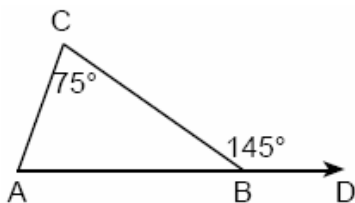

What is $m\angle CAB$?

- [A] 220 [B] 70 [C] 35 [D] 110

21. What is the measure of the largest angle in the accompanying triangle?

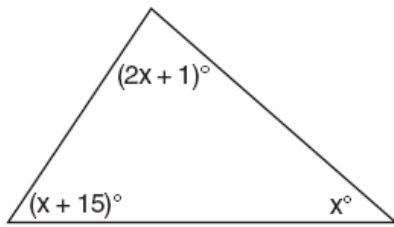

- [A] 83 [B] 46.5 [C] 56 [D] 41

22. In $\triangle ABC$, the measure of $\angle B$ is 21 less than four times the measure of $\angle A$, and the measure of $\angle C$ is 1 more than five times the measure of $\angle A$. Find the measure, in degrees, of *each* angle of $\triangle ABC$.

23. On the banks of a river, surveyors marked locations A , B , and C . The measure of $\angle ACB = 70^\circ$ and the measure of $\angle ABC = 65^\circ$.

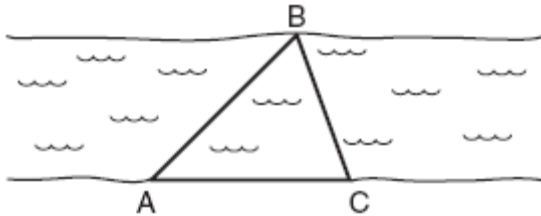

Which expression shows the relationship between the lengths of the sides of this triangle?

- [A] $BC < AB < AC$ [B] $AC < AB < BC$
[C] $BC < AC < AB$ [D] $AB < BC < AC$

24. In which of the accompanying figures are segments XY and YZ perpendicular?

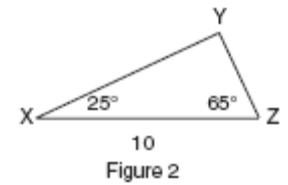
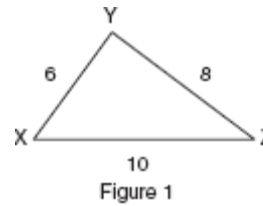

- [A] neither figure 1 nor figure 2
[B] both figure 1 and figure 2
[C] figure 2 only [D] figure 1, only

25. In the accompanying diagram, \overline{ABCD} is a straight line, and angle E in triangle BEC is a right angle.

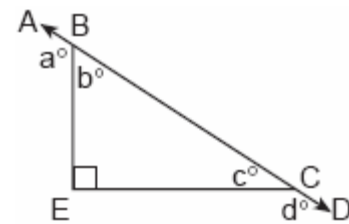

What does $a^\circ + d^\circ$ equal?

- [A] 270° [B] 180°
[C] 135° [D] 160°

SPECIAL TRIANGLES

26. Which phrase does *not* describe a triangle?

- [A] obtuse right [B] isosceles right
[C] acute scalene
[D] equilateral equiangular

27. In right triangle ABC , $m\angle C = 3y - 10$, $m\angle B = y + 40$, and $m\angle A = 90$. What type of right triangle is triangle ABC ?

- [A] isosceles [B] obtuse
[C] equilateral [D] scalene

28. If the measures of the angles of a triangle are represented by $2x$, $3x - 15$, and $7x + 15$, the triangle is
- [A] an acute triangle
[B] an equiangular triangle
[C] an isosceles triangle
[D] a right triangle

33. What is the measure, in degrees, of each exterior angle of a regular hexagon?
[A] 135 [B] 45 [C] 60 [D] 120
34. A stop sign in the shape of a regular octagon is resting on a brick wall, as shown in the accompanying diagram.

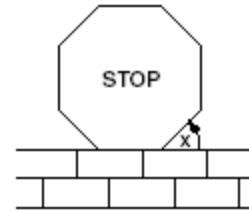

What is the measure of angle x ?

- [A] 60° [B] 120° [C] 135° [D] 45°

CHAPTER 2-2

INTERIOR AND EXTERIOR ANGLES OF OTHER POLYGONS

29. What is the sum, in degrees, of the measures of the interior angles of a stop sign, which is in the shape of an octagon?
[A] 1,080 [B] 360
[C] 1,880 [D] 1,440
30. The sum of the measures of the interior angles of an octagon is
[A] $1,080^\circ$ [B] 540°
[C] 180° [D] 360°
31. What is the sum, in degrees, of the measures of the interior angles of a pentagon?
[A] 900 [B] 540 [C] 360 [D] 180
32. The accompanying figure represents a section of bathroom floor tiles shaped like regular hexagons.



What is the measure of angle ABC ?

- [A] 150° [B] 90°
[C] 60° [D] 120°

35. One piece of the birdhouse that Natalie is building is shaped like a regular pentagon, as shown in the accompanying diagram.

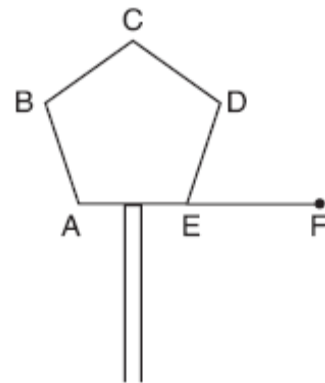

If side AE is extended to point F , what is the measure of exterior angle DEF ?

- [A] 72° [B] 144° [C] 36° [D] 108°

36. Melissa is walking around the outside of a building that is in the shape of a regular polygon. She determines that the measure of one exterior angle of the building is 60° . How many sides does the building have?
[A] 9 [B] 6 [C] 3 [D] 12

CHAPTER 2-4

SPECIAL QUADRILATERALS

37. Which statement about quadrilaterals is true?

- [A] All quadrilaterals have four sides.
- [B] All quadrilaterals are parallelograms.
- [C] All quadrilaterals have equal sides.
- [D] All quadrilaterals have four right angles.

38. Which statement is *not* always true about a parallelogram?

- [A] The opposite sides are congruent.
- [B] The diagonals are congruent.
- [C] The opposite angles are congruent.
- [D] The opposite sides are parallel.

39. A set of five quadrilaterals consists of a square, a rhombus, a rectangle, an isosceles trapezoid, and a parallelogram. Lu selects one of these figures at random. What is the probability that both pairs of the figure's opposite sides are parallel?

- [A] $\frac{2}{5}$ [B] $\frac{3}{4}$ [C] $\frac{4}{5}$ [D] 1

40. In a certain quadrilateral, two opposite sides are parallel, and the other two opposite sides are *not* congruent. This quadrilateral could be a

- [A] rhombus [B] square
- [C] parallelogram [D] trapezoid

41. Al says, "If $ABCD$ is a parallelogram, then $ABCD$ is a rectangle." Sketch a quadrilateral $ABCD$ that shows that Al's statement is not always true. Your sketch must show the length of each side and the measure of each angle for the quadrilateral you draw.

42. The cross section of an attic is in the shape of an isosceles trapezoid, as shown in the accompanying figure. If the height of the attic is 9 feet, $BC = 12$ feet, and $AD = 28$ feet, find the length of \overline{AB} to the *nearest foot*.

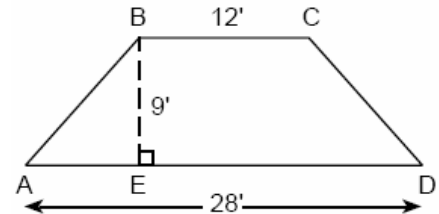

CHAPTER 2-5

CIRCLE GRAPHS

43. The accompanying circle graph shows how the Marino family spends its income each month.

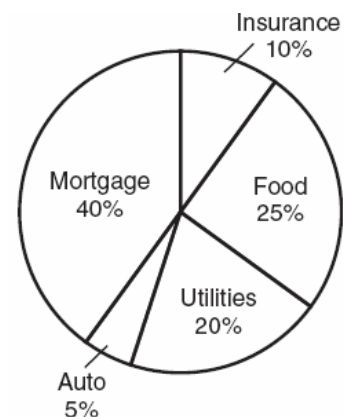

What is the measure, in degrees, of the central angle that represents the percentage of income spent on food?

- [A] 90 [B] 50 [C] 360 [D] 25

44. The accompanying circle graph shows how Shannon earned \$600 during her summer vacation.



What is the measure of the central angle of the section labeled "Chores"?

- [A] 60° [B] 90° [C] 30° [D] 120°

45. Mr. Smith's class voted on their favorite ice cream flavors, and the results are shown in the accompanying diagram. If there are 20 students in Mr. Smith's class, how many students chose coffee ice cream as their favorite flavor?

Favorite Ice Cream Flavors

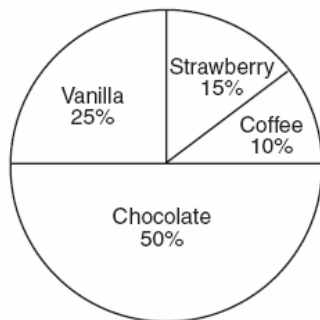

46. The accompanying circle graph shows the favorite colors of the 300 students in the ninth grade. How many students chose red as their favorite color?

Favorite Colors

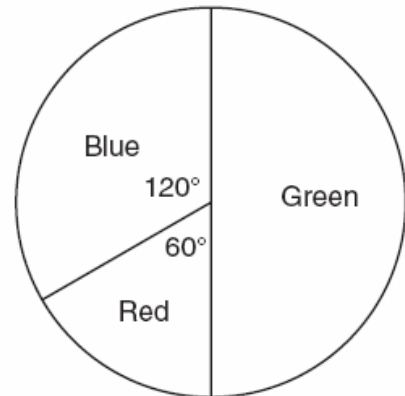

47. In a recent poll, 600 people were asked whether they liked Chinese food. A circle graph was constructed to show the results. The central angles for two of the three sectors are shown in the accompanying diagram. How many people had no opinion?

Chinese Food

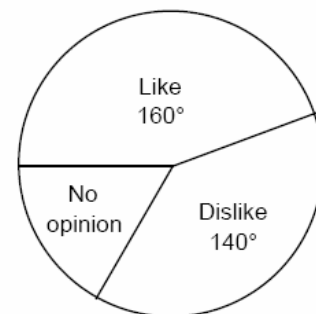

48. Nine hundred students were asked whether they thought their school should have a dress code. A circle graph was constructed to show the results. The central angles for two of the three sectors are shown in the accompanying diagram. What is the number of students who felt that the school should have no dress code?

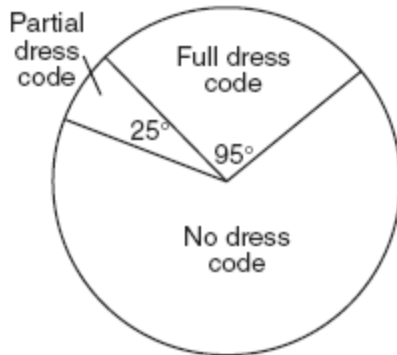

49. In a recent poll in Syracuse, New York, 3,000 people were asked to pick their favorite baseball team. The accompanying circle graph shows the results of that poll.

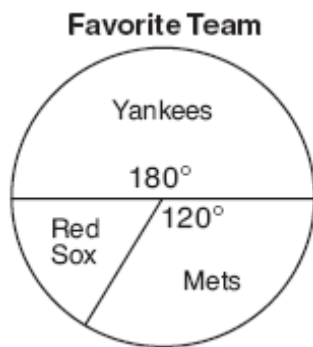

How many of the people polled picked the Red Sox as their favorite team?

- [A] 1,200 [B] 500 [C] 300 [D] 1,800

50. In a class of 24 students, 10 have brown hair, 8 have black hair, 4 have blond hair, and 2 have red hair. On the accompanying diagram, construct a circle graph to show the students' hair color.

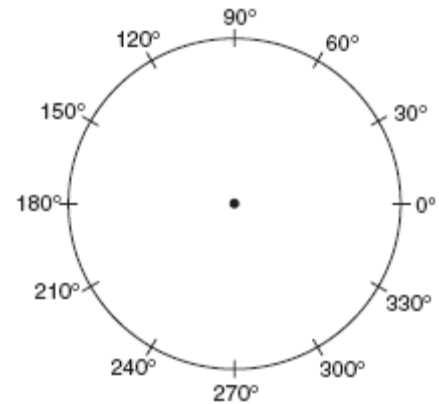

CHAPTER 3

IDENTIFYING TRANSFORMATIONS

51. Which transformation does *not* always produce an image that is congruent to the original figure?
- [A] rotation [B] translation
[C] dilation [D] reflection
52. Which transformation does *not* always result in an image that is congruent to the original figure?
- [A] dilation [B] reflection
[C] rotation [D] translation

53. In the accompanying diagram, which transformation changes the solid-line parabola to the dotted-line parabola?

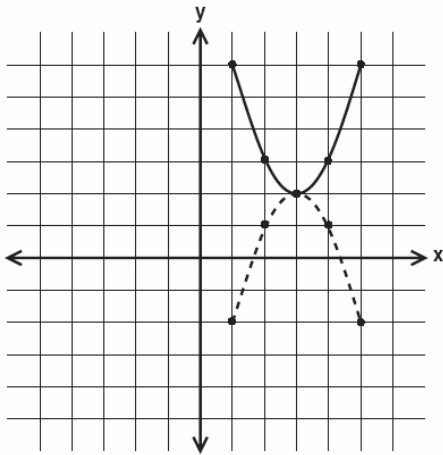

- [A] rotation, only
 [B] line reflection, only [C] translation
 [D] line reflection or rotation

54. In the accompanying diagram, $\triangle ABC$ is similar to but not congruent to $\triangle A'B'C'$. Which transformation is represented by $\triangle A'B'C'$?

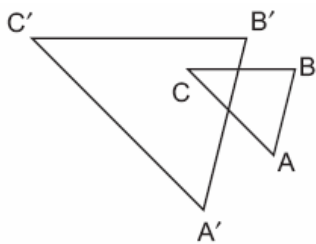

- [A] reflection [B] rotation
 [C] translation [D] dilation

55. The transformation of $\triangle ABC$ to $\triangle AB'C'$ is shown in the accompanying diagram.

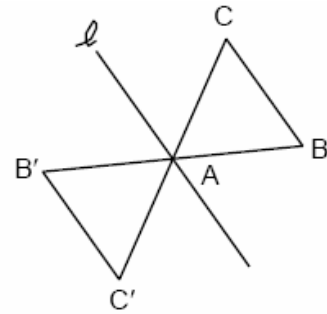

This transformation is an example of a

- [A] line reflection in line l
 [B] dilation
 [C] rotation about point A [D] translation

56. The accompanying diagram shows a transformation.

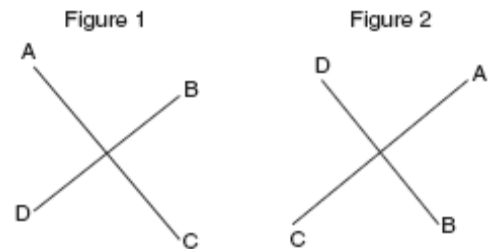

Which transformation performed on figure 1 resulted in figure 2?

- [A] rotation [B] translation
 [C] reflection [D] dilation

57. The accompanying diagram shows the transformation of $\triangle XYZ$ to $\triangle X'Y'Z'$.

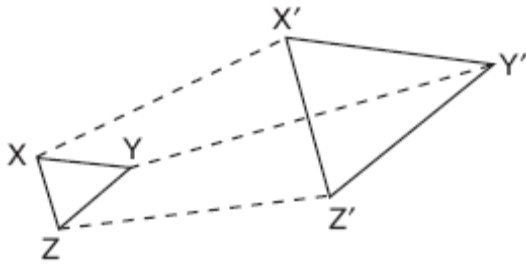

- This transformation is an example of a
 [A] rotation [B] translation
 [C] dilation [D] line reflection

58. Which type of transformation is illustrated in the accompanying diagram?

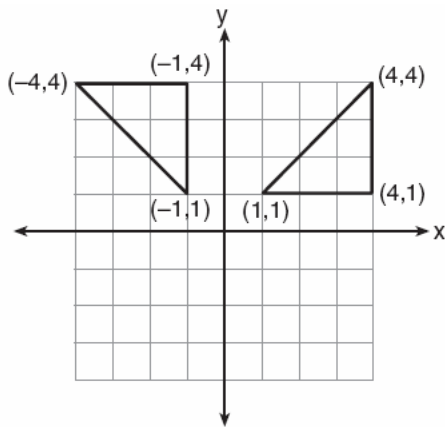

- [A] reflection [B] translation
 [C] rotation [D] dilation

59. A picture held by a magnet to a refrigerator slides to the bottom of the refrigerator, as shown in the accompanying diagram.

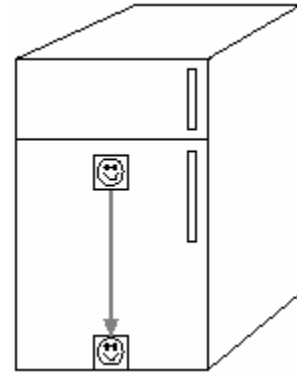

- This change of position is an example of a
 [A] dilation [B] reflection
 [C] translation [D] rotation

60. As shown in the accompanying diagram, the star in position 1 on a computer screen transforms to the star in position 2.

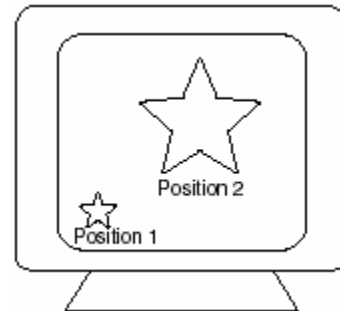

- This transformation is best described as a
 [A] translation [B] rotation
 [C] dilation [D] line reflection

61. One function of a movie projector is to enlarge the image on the film. This procedure is an example of a

- [A] line of symmetry [B] translation
 [C] line reflection [D] dilation

62. Which transformation of the graph of $y = x^2$ would result in the graph of $y = x^2 + 2$?

- [A] $r_{y=2}$ [B] D_2 [C] $T_{0,2}$ [D] $R_{0,90}$

CHAPTER 3-1

ISOMETRIES

63. Which transformation is *not* an isometry?

- [A] $T_{3,6}$ [B] $r_{y=x}$ [C] $R_{0,90^\circ}$ [D] D_2

64. Which transformation is *not* an isometry?

- [A] line reflection [B] rotation
[C] dilation [D] translation

65. Which transformation is a direct isometry?

- [A] D_{-2} [B] $T_{2,5}$ [C] D_2 [D] $r_{y\text{-axis}}$

66. Which transformation is an opposite isometry?

- [A] line reflection [B] rotation of 90°
[C] translation [D] dilation

67. Which transformation is an example of an opposite isometry?

- [A] $(x,y) \rightarrow (x + 3,y - 6)$
[B] $(x,y) \rightarrow (3x,3y)$
[C] $(x,y) \rightarrow (y,x)$ [D] $(x,y) \rightarrow (y,-x)$

68. Which transformation does *not* preserve orientation?

- [A] dilation
[B] reflection in the y -axis
[C] translation [D] rotation

REFLECTIONS

69. What is the image of point $(-3, -1)$ under a reflection in the origin?

- [A] $(3, 1)$ [B] $(-1, -3)$
[C] $(-3, 1)$ [D] $(1, 3)$

70. If $x = -3$ and $y = 2$, which point on the accompanying graph represents $(-x, -y)$?

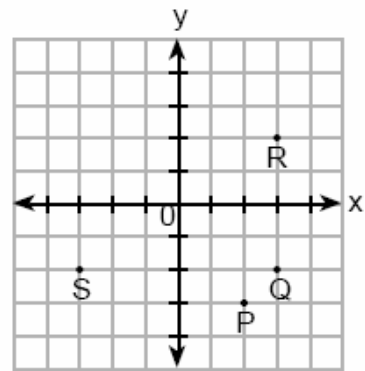

- [A] Q [B] S [C] P [D] R

71. Ms. Brewer's art class is drawing reflected images. She wants her students to draw images reflected in a line. Which diagram represents a correctly drawn image?

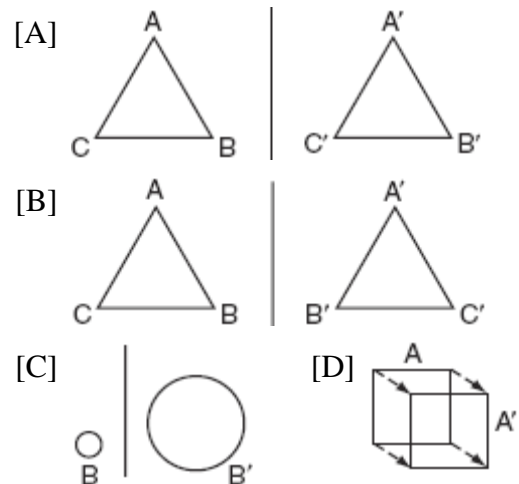

72. When the point $(2, -5)$ is reflected in the x -axis, what are the coordinates of its image?

- [A] $(5, 2)$ [B] $(-5, 2)$
[C] $(2, 5)$ [D] $(-2, 5)$

73. Which image represents a line reflection?

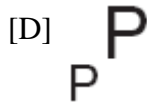
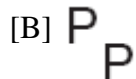
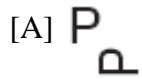

74. The coordinates of the endpoints of \overline{AB} are $A(0,2)$ and $B(4,6)$. Graph and state the coordinates of A' and B' , the images of A and B after \overline{AB} is reflected in the x -axis.

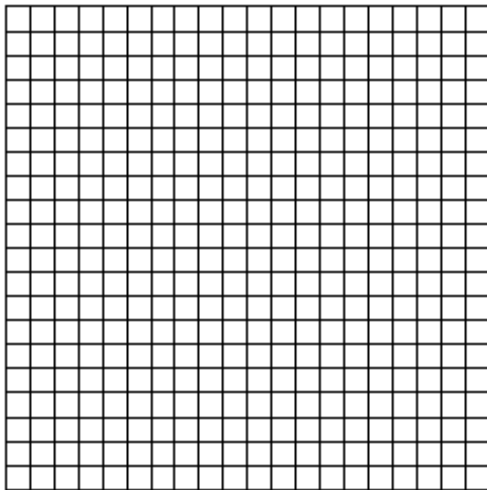

75. Triangle SUN has coordinates $S(0,6)$, $U(3,5)$, and $N(3,0)$. On the accompanying grid, draw and label $\triangle SUN$. Then, graph and state the coordinates of $\triangle S'U'N'$, the image of $\triangle SUN$ after a reflection in the y -axis.

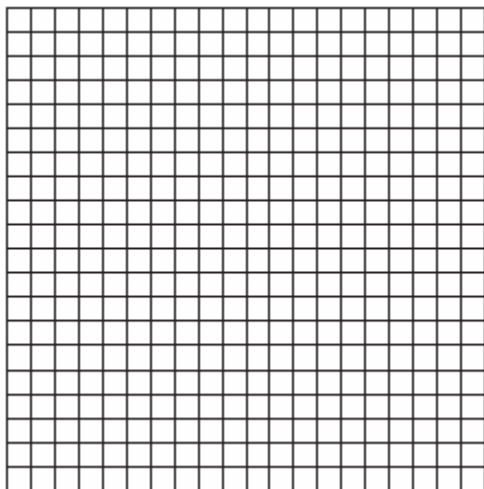

76. On the accompanying set of axes, draw the reflection of $ABCD$ in the y -axis. Label and state the coordinates of the reflected figure.

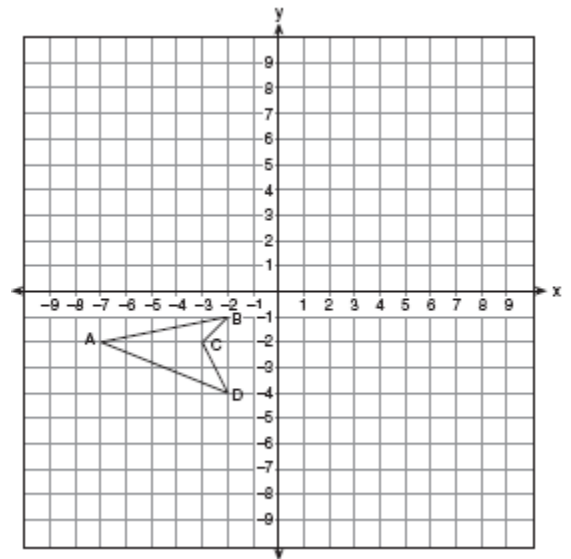

77. Triangle ABC has coordinates $A(2,0)$, $B(1,7)$, and $C(5,1)$. On the accompanying set of axes, graph, label, and state the coordinates of $\triangle A'B'C'$, the reflection of $\triangle ABC$ in the y -axis.

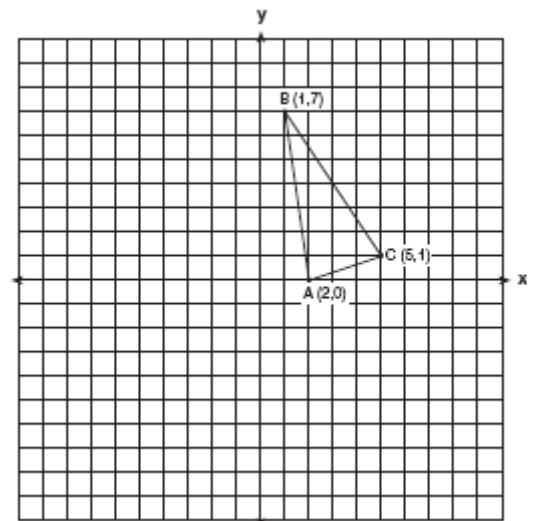

78. Carson is a decorator. He often sketches his room designs on the coordinate plane. He has graphed a square table on his grid so that its corners are at the coordinates $A(2,6)$, $B(7,8)$, $C(9,3)$, and $D(4,1)$. To graph a second identical table, he reflects $ABCD$ over the y -axis. On the accompanying set of coordinate axes, sketch and label $ABCD$ and its image $A'B'C'D'$, which show the locations of the two tables. Then find the number of square units in the area of $ABCD$.

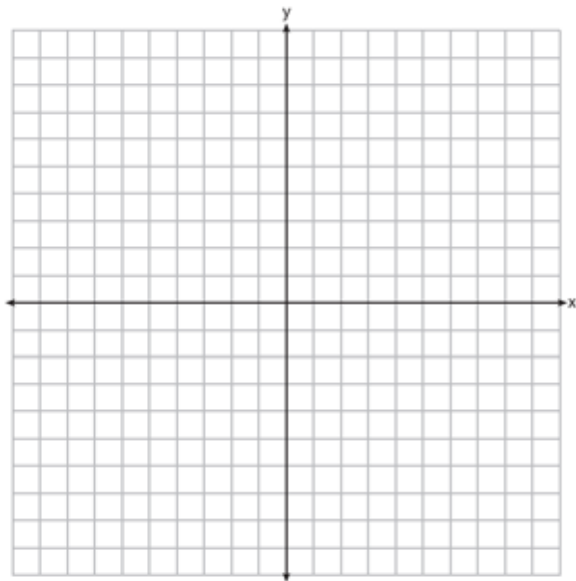

79. What are the coordinates of point P , the image of point $(3,-4)$ after a reflection in the line $y = x$?
- [A] $(-4,3)$ [B] $(4,-3)$
 [C] $(-3,4)$ [D] $(3,4)$
80. A function, f , is defined by the set $\{(2,3), (4,7), (-1,5)\}$. If f is reflected in the line $y = x$, which point will be in the reflection?
- [A] $(5,-1)$ [B] $(-1,5)$
 [C] $(1-5)$ [D] $(-5,1)$

81. Which transformation best describes the relationship between the functions $f(x) = 2^x$ and $g(x) = (\frac{1}{2})^x$?
- [A] reflection in the origin
 [B] reflection in the line $y = x$
 [C] reflection in the x -axis
 [D] reflection in the y -axis
82. In the accompanying diagram of square $ABCD$, F is the midpoint of \overline{AB} , G is the midpoint of \overline{BC} , H is the midpoint of \overline{CD} , and E is the midpoint of \overline{DA} .

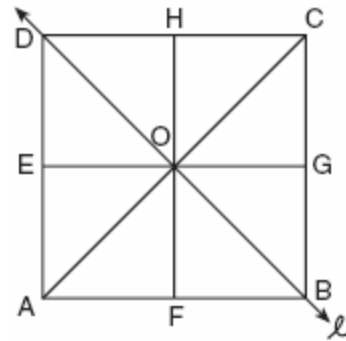

Find the image of $\triangle EOA$ after it is reflected in line ℓ .
 Is this isometry direct or opposite? Explain your answer.

83. The accompanying graph represents the equation $y = f(x)$.

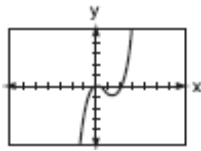

Which graph represents $g(x)$, if $g(x) = -f(x)$?

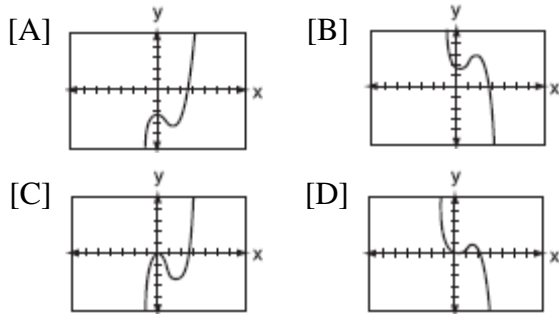

84. The graph below represents $f(x)$.



Which graph best represents $f(-x)$?

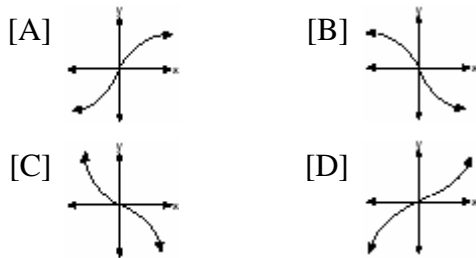

CHAPTER 3-2

TRANSLATIONS

85. If $x = -2$ and $y = -1$, which point on the accompanying set of axes represents the translation $(x, y) \rightarrow (x + 2, y - 3)$?

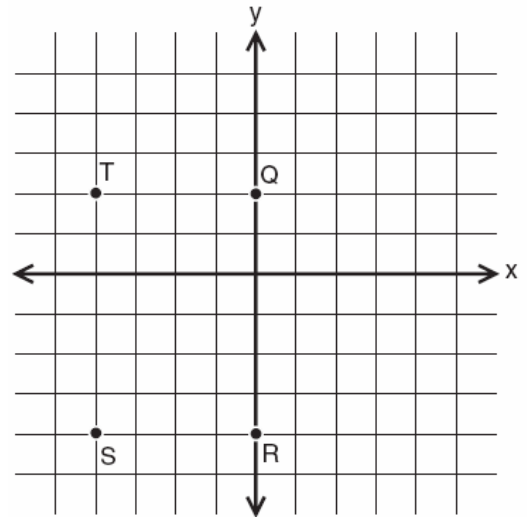

- [A] R [B] Q [C] S [D] T

86. What is the image of (x, y) after a translation of 3 units right and 7 units down?

- [A] $(x - 3, y - 7)$ [B] $(x + 3, y + 7)$
[C] $(x + 3, y - 7)$ [D] $(x - 3, y + 7)$

87. What is the image of point $(2, 5)$ under the translation that shifts (x, y) to $(x + 3, y - 2)$?

- [A] $(0, 8)$ [B] $(5, 8)$ [C] $(0, 3)$ [D] $(5, 3)$

88. What are the coordinates of P' , the image of $P(-4, 0)$ under the translation $(x - 3, y + 6)$?

- [A] $(1, 6)$ [B] $(-7, 6)$
[C] $(2, -3)$ [D] $(7, -6)$

89. The image of point $(3, -5)$ under the translation that shifts (x, y) to $(x - 1, y - 3)$ is

- [A] $(2, 8)$ [B] $(-4, 8)$
[C] $(2, -8)$ [D] $(-3, 15)$

90. What is the image of point $(-3, 4)$ under the translation that shifts (x,y) to $(x - 3, y + 2)$?
- [A] $(-6,6)$ [B] $(0,6)$
[C] $(-6,8)$ [D] $(6,6)$
91. A translation moves $P(3,5)$ to $P'(6,1)$. What are the coordinates of the image of point $(-3,-5)$ under the same translation?
- [A] $(-6,-1)$ [B] $(-5,-3)$
[C] $(-6,-9)$ [D] $(0,-9)$
92. The image of point $(-2,3)$ under translation T is $(3,-1)$. What is the image of point $(4,2)$ under the same translation?
- [A] $(-1,6)$ [B] $(0,7)$
[C] $(5,4)$ [D] $(9,-2)$
93. The image of the origin under a certain translation is the point $(2,-6)$. The image of point $(-3,-2)$ under the same translation is the point
- [A] $(-1,-8)$ [B] $(-6,12)$
[C] $(-\frac{3}{2}, \frac{1}{3})$ [D] $(-5,4)$

94. Two parabolic arches are to be built. The equation of the first arch can be expressed as $y = -x^2 + 9$, with a range of $0 \leq y \leq 9$, and the second arch is created by the transformation $T_{7,0}$. On the accompanying set of axes, graph the equations of the two arches. Graph the line of symmetry formed by the parabola and its transformation and label it with the proper equation.

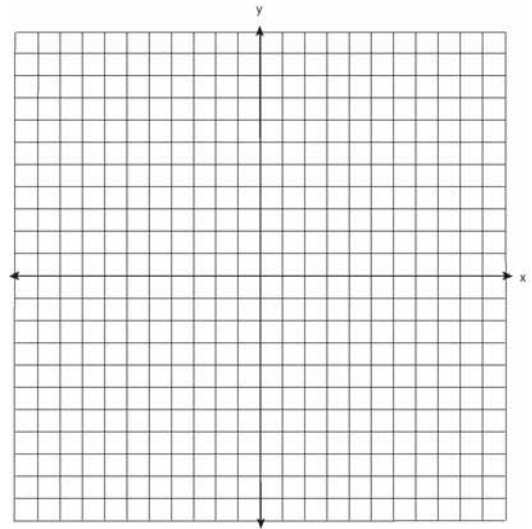

CHAPTER 3-3

ROTATIONS

95. In the accompanying graph, if point P has coordinates (a,b) , which point has coordinates $(-b,a)$?

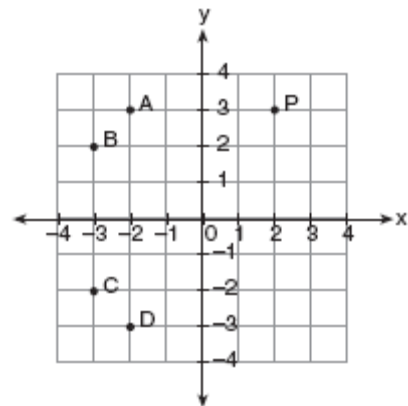

- [A] B [B] A [C] D [D] C

96. Point P' is the image of point $P(-3,4)$ after a translation defined by $T_{(7,-1)}$. Which other transformation on P would also produce P' ?

- [A] $r_{y=-x}$ [B] R_{90°
[C] r_{y-axis} [D] R_{-90°

100. What are the coordinates of point A' , the image of point $A(-4,1)$ after the composite transformation $R_{90^\circ} \circ r_{y=x}$ where the origin is the center of rotation?

- [A] $(-1,-4)$ [B] $(1,4)$
[C] $(4,1)$ [D] $(-4,-1)$

CHAPTER 3-4

COMPOSITIONS OF TRANSFORMATIONS

97. The coordinates of the endpoints of \overline{AB} are $A(2,6)$ and $B(4,2)$. Is the image $\overline{A''B''}$ the same if it is reflected in the x -axis, then dilated by $\frac{1}{2}$ as the image is if it is dilated by $\frac{1}{2}$, then reflected in the x -axis? Justify your answer.

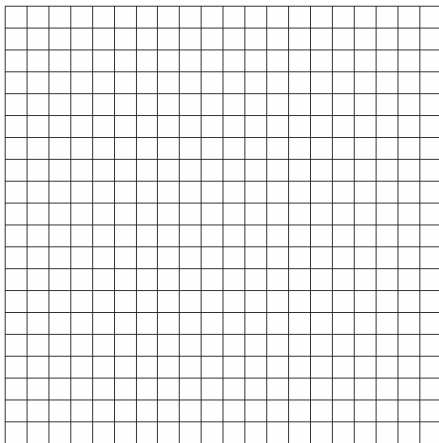

98. If the coordinates of point A are $(-2,3)$, what is the image of A under $r_{y-axis} \circ D_3$?

- [A] $(-6,-9)$ [B] $(6,9)$
[C] $(9,-6)$ [D] $(5,6)$

99. What is the image of point $(1,1)$ under $r_{x-axis} \circ R_{0,90^\circ}$?

- [A] $(-1,1)$ [B] $(1,-1)$
[C] $(-1,-1)$ [D] $(1,1)$

101. If $f(x) = \cos x$, which graph represents $f(x)$ under the composition $r_{y-axis} \circ r_{x-axis}$?

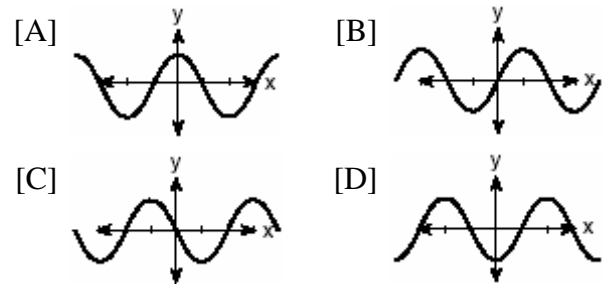

102. The graph of $f(x)$ is shown in the accompanying diagram.

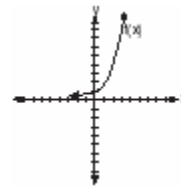

Which graph represents $f(x)_{r_{x-axis} \circ r_{y-axis}}$?

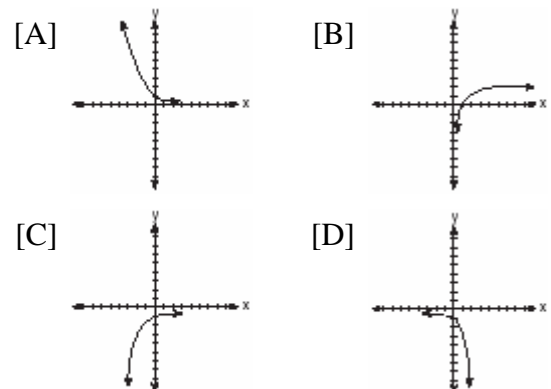

103. The accompanying graph represents the figure \square .

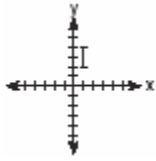

Which graph represents \square after a transformation defined by $r_{y=x} \circ R_{90^\circ}$?

- [A] [B]
- [C] [D]

104. a On the accompanying grid, graph the equation $2y = 2x^2 - 4$ in the interval $-3 \leq x \leq 3$ and label it a .
b On the same grid, sketch the image of a under $T_{5,-2} \circ r_{x\text{-axis}}$ and label it b .

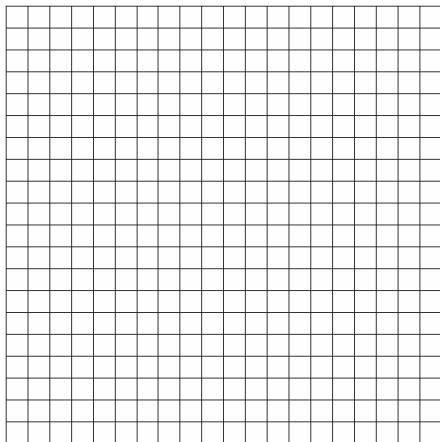

105. Graph and label the following equations, a and b , on the accompanying set of coordinate axes.

$$a: y = x^2$$

$$b: y = -(x-4)^2 + 3$$

Describe the composition of transformations performed on a to get b .

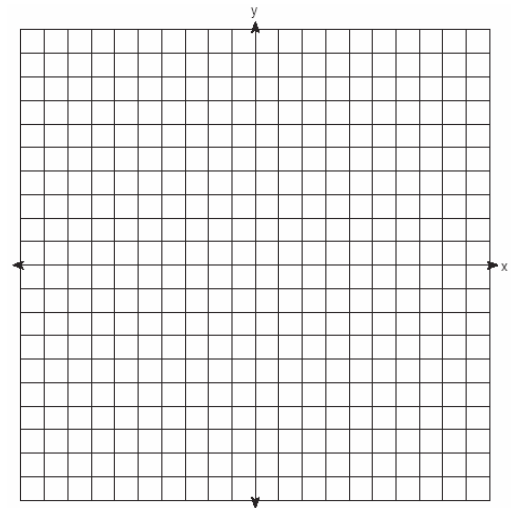

106. On the accompanying grid, graph and label \overline{AB} , where A is $(0,5)$ and B is $(2,0)$. Under the transformation $r_{x\text{-axis}} \circ r_{y\text{-axis}}(\overline{AB})$, A maps to A'' and B maps to B'' . Graph and label $\overline{A''B''}$. What single transformation would map \overline{AB} to $\overline{A''B''}$?

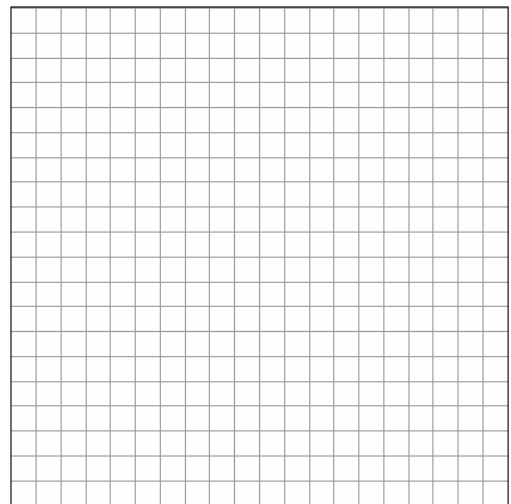

107. Given point $A(-2,3)$. State the coordinates of the image of A under the composition $T_{-3,-4} \circ r_{x\text{-axis}}$. [The use of the accompanying grid is optional.]

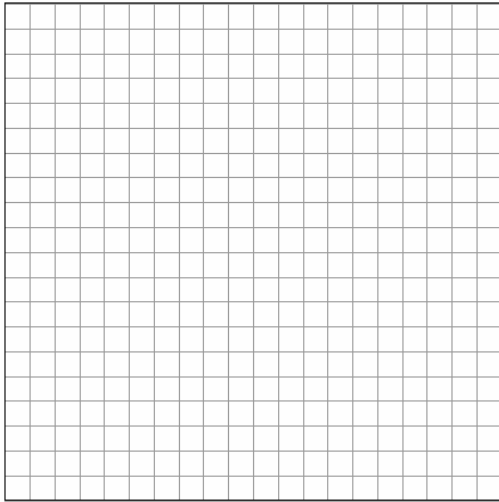

113. Which letter demonstrates line symmetry but *not* point symmetry?
[A] **N** [B] **H** [C] **T** [D] **S**
114. Helen is using a capital H in an art design. The H has
[A] only one line of symmetry
[B] only two points of symmetry
[C] two lines of symmetry and only one point of symmetry
[D] two lines of symmetry and two points of symmetry

115. Which graph is symmetric with respect to the y -axis?

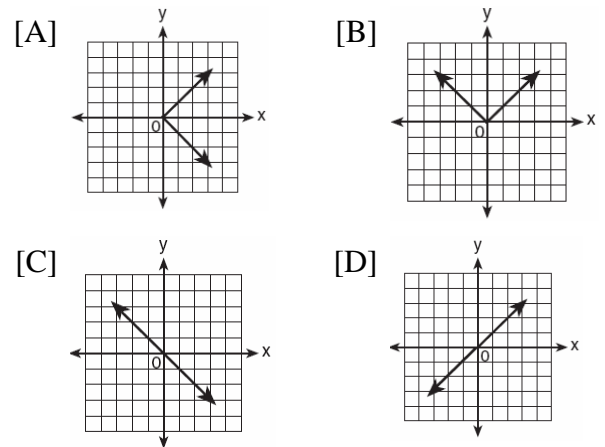

116. Which diagram shows a dotted line that is *not* a line of symmetry?

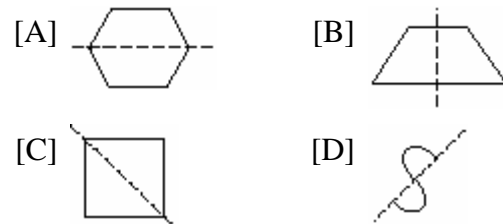





CHAPTER 3-5

SYMMETRY

108. Which letter has point symmetry?
[A] B [B] W [C] A [D] H
109. Which shape does *not* have rotational symmetry?
[A] square [B] trapezoid
[C] regular pentagon [D] circle
110. Which letter has both point and line symmetry?
[A] C [B] Z [C] T [D] H
111. Which letter has point symmetry, but *not* line symmetry?
[A] H [B] S [C] T [D] X
112. Which letter below has point symmetry, but does not have line symmetry?
[A] E [B] N [C] A [D] H

117. Which geometric figure has one and only one line of symmetry?

- [A]  Rhombus
- [B]  Square
- [C]  Isosceles trapezoid
- [D]  Rectangle

118. Draw all the symmetry lines on the accompanying figure.

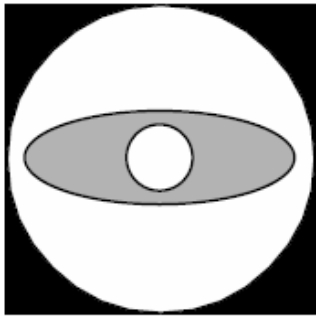

119. On the accompanying square, draw all the lines of symmetry.

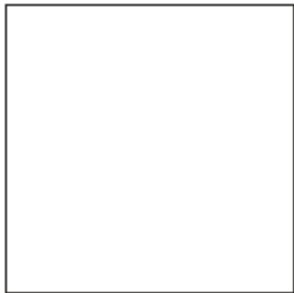

CHAPTER 3-7

DILATIONS

120. Triangle $A'B'C'$ is the image of $\triangle ABC$ under a dilation such that $A'B' = 3AB$. Triangles ABC and $A'B'C'$ are

- [A] neither congruent nor similar
[B] similar but not congruent
[C] both congruent and similar
[D] congruent but not similar

121. The image of point A after a dilation of 3 is $(6,15)$. What was the original location of point A ?

- [A] $(18,45)$ [B] $(3,12)$
[C] $(9,18)$ [D] $(2,5)$

122. On the accompanying set of axes, graph $\triangle ABC$ with coordinates $A(-1,2)$, $B(0,6)$, and $C(5,4)$. Then graph $\triangle A'B'C'$, the image of $\triangle ABC$ after a dilation of 2.

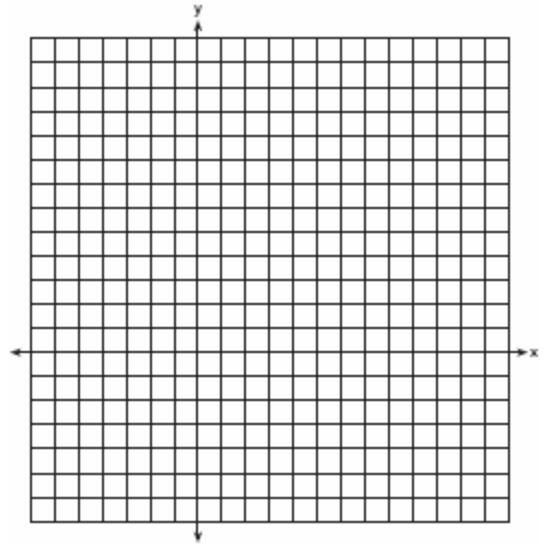

123. Which transformation represents a dilation?

- [A] $(8,4) \rightarrow (4,2)$ [B] $(8,4) \rightarrow (-4,-8)$
[C] $(8,4) \rightarrow (11,7)$ [D] $(8,4) \rightarrow (-8,4)$

124. In which quadrant would the image of point $(5, -3)$ fall after a dilation using a factor of -3 ?

- [A] III [B] IV [C] I [D] II

125. The graph of the function $g(x)$ is shown on the accompanying set of axes. On the same set of axes, sketch the image of $g(x)$ under the transformation D_2 .

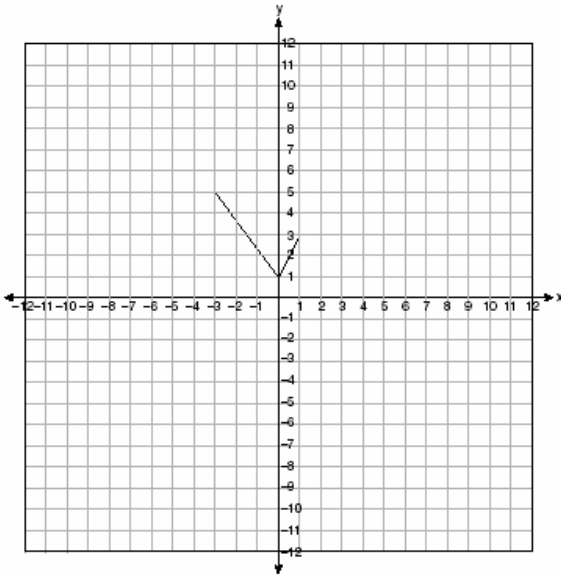

126. In the accompanying graph, the shaded region represents set A of all points (x,y) such that $x^2 + y^2 \leq 1$. The transformation T maps point (x, y) to point $(2x, 4y)$.

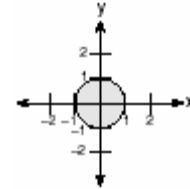

Which graph shows the mapping of set A by the transformation T ?

[A]

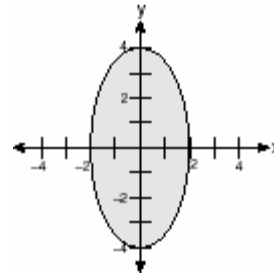

[B]

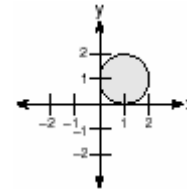

[C]

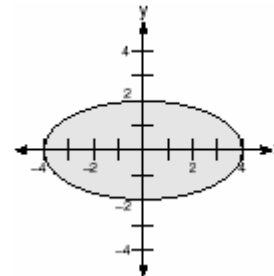

[D]

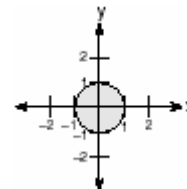

CHAPTER 4-1

NY LESSON 13

LOGICAL REASONING

127. What is the smallest integer greater than 1 that is both the square of an integer and the cube of an integer?
[A] 8 [B] 9 [C] 36 [D] 64
128. Stan was trying to guess Melanie's age. She told him her age was an even number and a multiple of three. What could be Melanie's age?
[A] 10 [B] 15 [C] 12 [D] 16
129. Seth is thinking of a number between 20 and 30. The number is prime and not more than 2 away from a perfect square. What is the number?
130. The statement " x is *not* the square of an integer and x is a multiple of 3" is true when x is equal to
[A] 9 [B] 32 [C] 18 [D] 36
131. The statement " $x \geq 4$ and $2x - 4 < 6$ " is true when x is equal to
[A] 1 [B] 5 [C] 10 [D] 4
132. Bob and Ray are describing the same number. Bob says, "The number is a positive even integer less than or equal to 20." Ray says, "The number is divisible by 4." If Bob's statement is true and Ray's statement is false, what are all the possible numbers?
133. The statement " x is divisible by 5 or x is divisible by 4" is *false* when x equals
[A] 20 [B] 27 [C] 16 [D] 10
134. Mary says, "The number I am thinking of is divisible by 2 or it is divisible by 3." Mary's statement is false if the number she is thinking of is
[A] 6 [B] 11 [C] 8 [D] 15
135. Given the true statement "John is not handsome" and the false statement "John is handsome or smart." Determine the truth value for the statement "John is smart."
136. Mark says, "The number I see is odd." Jan says, "That same number is prime." The teacher says, "Mark is correct or Jan is correct." Some integers would make the teacher's statement true while other integers would make it false. Give and explain one example of when the teacher's statement is true. Give and explain one example of when the teacher's statement is false.
137. If $x = 3$, which statement is *false*?
[A] x is odd or x is even.
[B] x is prime and x is odd.
[C] x is odd and $2x$ is even.
[D] x is not prime and x is odd.
138. Given the true statements: "Jason goes shopping or he goes to the movies" and "Jason does not go to the movies." Which statement must also be true?
[A] Jason does not go shopping and he does not go to the movies.
[B] Jason does not go shopping.
[C] Jason stays home.
[D] Jason goes shopping.
139. The statement "If x is divisible by 8, then it is divisible by 6" is false if x equals
[A] 14 [B] 32 [C] 6 [D] 48

140. The statement "If x is prime, then it is odd" is false when x equals
[A] 4 [B] 3 [C] 1 [D] 2
141. Given the statement: "If x is a rational number, then \sqrt{x} is irrational." Which value of x makes the statement *false*?
[A] 2 [B] 4 [C] $\frac{3}{2}$ [D] 3
145. Which statement is logically equivalent to "If I eat, then I live"?
[A] I live if and only if I eat.
[B] If I live, then I eat.
[C] If I do not live, then I do not eat.
[D] If I eat, then I do not live.
146. Which statement is logically equivalent to "If a triangle is an isosceles triangle, then it has two congruent sides"?
[A] If a triangle does not have two congruent sides, then it is not an isosceles triangle.
[B] If a triangle is an isosceles triangle, then it does not have two congruent sides.
[C] If a triangle is not an isosceles triangle, then it has two congruent sides.
[D] If a triangle does not have two congruent sides, then it is an isosceles triangle.

CONTRAPOSITIVE

142. What is the contrapositive of the statement "If I study, then I pass the test"?
[A] If I do not pass the test, then I do not study.
[B] If I do not study, then I do not pass the test.
[C] I pass the test if I study.
[D] If I pass the test, then I study.
143. Which statement is logically equivalent to "If it is Saturday, then I am not in school"?
[A] If I am not in school, then it is Saturday.
[B] If it is Saturday, then I am in school.
[C] If it is not Saturday, then I am in school.
[D] If I am in school, then it is not Saturday.
144. Which statement is logically equivalent to "If I did not eat, then I am hungry"?
[A] If I did not eat, then I am not hungry.
[B] If I am not hungry, then I did eat.
[C] If I am hungry, then I did eat.
[D] If I am not hungry, then I did not eat.
147. Which statement is logically equivalent to "If the team has a good pitcher, then the team has a good season"?
[A] If the team does not have a good pitcher, then the team does not have a good season.
[B] If the team does not have a good season, then the team does not have a good pitcher.
[C] If the team has a good season, then the team has a good pitcher.
[D] The team has a good pitcher and the team does not have a good season.

148. Which statement is logically equivalent to the statement "If you are an elephant, then you do not forget"?
- [A] If you do not forget, then you are not an elephant.
 - [B] If you do not forget, then you are an elephant.
 - [C] If you forget, then you are not an elephant.
 - [D] If you are an elephant, then you forget.
149. Which statement is logically equivalent to the statement "If Corey worked last summer, he buys a car"?
- [A] If Corey does not buy a car, he did not work last summer.
 - [B] If you are an elephant, then you forget.
 - [C] If Corey did not work last summer, he does not buy a car.
 - [D] If Corey buys a car, he worked last summer.
150. Given the true statement: "If a person is eligible to vote, then that person is a citizen." Which statement must also be true?
- [A] Morgan has never voted; therefore, he is not a citizen.
 - [B] Marie is not eligible to vote; therefore, she is not a citizen.
 - [C] Juan is a citizen; therefore, he is eligible to vote.
 - [D] Kayla is not a citizen; therefore, she is not eligible to vote.

CONVERSE AND BICONDITIONAL

151. Which statement is the converse of "If the sum of two angles is 180° , then the angles are supplementary"?
- [A] If the sum of two angles is not 180° , then the angles are supplementary.
 - [B] If the sum of two angles is not 180° , then the angles are not supplementary.
 - [C] If two angles are not supplementary, then their sum is not 180° .
 - [D] If two angles are supplementary, then their sum is 180° .
152. What is the converse of the statement "If it is sunny, I will go swimming"?
- [A] If I go swimming, it is sunny.
 - [B] If I do not go swimming, then it is not sunny.
 - [C] I will go swimming if and only if it is sunny.
 - [D] If it is not sunny, I will not go swimming.
153. Which statement is the converse of "If it is a 300 ZX, then it is a car"?
- [A] If it is a car, then it is a 300 ZX.
 - [B] If it is not a 300 ZX, then it is not a car.
 - [C] If it is a car, then it is not a 300 ZX.
 - [D] If it is not a car, then it is not a 300 ZX.
154. What is the converse of the statement "If it is Sunday, then I do not go to school"?
- [A] If it is not Sunday, then I go to school.
 - [B] If I go to school, then it is not Sunday.
 - [C] If I do not go to school, then it is Sunday.
 - [D] If it is not Sunday, then I do not go to school.

155. What is the converse of the statement "If Alicia goes to Albany, then Ben goes to Buffalo"?
- [A] Alicia goes to Albany if and only if Ben goes to Buffalo.
- [B] If Ben does not go to Buffalo, then Alicia does not go to Albany.
- [C] If Ben goes to Buffalo, then Alicia goes to Albany.
- [D] If Alicia does not go to Albany, then Ben does not go to Buffalo.
156. What is the converse of the statement "If the Sun rises in the east, then it sets in the west"?
- [A] If the Sun sets in the west, then it rises in the east.
- [B] If the Sun rises in the west, then it sets in the east.
- [C] If the Sun does not rise in the east, then it does not set in the west.
- [D] If the Sun does not set in the west, then it does not rise in the east.
157. What is true about the statement "If two angles are right angles, the angles have equal measure " and its converse "If two angles have equal measure then the two angles are right angles"?
- [A] Both the statement and its converse are true.
- [B] The statement is true but its converse is false.
- [C] Both the statement and its converse are false.
- [D] The statement is false but its converse is true.
158. Given the statement: "If two lines are cut by a transversal so that the corresponding angles are congruent, then the lines are parallel." What is true about the statement and its converse?
- [A] The statement is false, but its converse is true.
- [B] The statement and its converse are both true.
- [C] The statement is true, but its converse is false.
- [D] The statement and its converse are both false.
159. Given the statement: "If two sides of a triangle are congruent, then the angles opposite these sides are congruent."
- Given the converse of the statement: "If two angles of a triangle are congruent, then the sides opposite these angles are congruent."
- What is true about this statement and its converse?
- [A] The statement is false but its converse is true.
- [B] Both the statement and its converse are true.
- [C] Neither the statement nor its converse is true.
- [D] The statement is true but its converse is false.

160. Given the statement: "A right angle measures 90° ." How is this statement written as a biconditional?
- [A] If an angle does not measure 90° , then it is not a right angle.
 - [B] An angle measures 90° and it is a right angle.
 - [C] If an angle is a right angle, then it measures 90° .
 - [D] An angle is a right angle if, and only if, it measures 90° .
161. Which statement is expressed as a biconditional?
- [A] Two angles are congruent if they have the same measure.
 - [B] Two angles are congruent if and only if they have the same measure.
 - [C] If two angles are both right angles, then they are congruent.
 - [D] If two angles are congruent, then they are both right angles.
- INVERSE**
162. What is the inverse of the statement "If Mike did his homework, then he will pass this test"?
- [A] If Mike does not pass this test, then he only did half his homework.
 - [B] If Mike passes this test, then he did his homework.
 - [C] If Mike did not do his homework, then he will not pass this test.
 - [D] If Mike does not pass this test, then he did not do his homework.
163. What is the inverse of the statement "If Julie works hard, then she succeeds"?
- [A] If Julie does not work hard, then she does not succeed.
 - [B] If Julie succeeds, then she works hard.
 - [C] If Julie works hard, then she does not succeed.
 - [D] If Julie does not succeed, then she does not work hard.
164. What is the inverse of the statement "If it is sunny, I will play baseball"?
- [A] If I do not play baseball, then it is not sunny.
 - [B] If I play baseball, then it is sunny.
 - [C] I will play baseball if and only if it is sunny.
 - [D] If it is not sunny, I will not play baseball.
165. What is the inverse of the statement "If I do not buy a ticket, then I do not go to the concert"?
- [A] If I buy a ticket, then I go to the concert.
 - [B] If I go to the concert, then I buy a ticket.
 - [C] If I buy a ticket, then I do not go to the concert.
 - [D] If I do not go to the concert, then I do not buy a ticket.
166. Which statement is the inverse of "If the waves are small, I do not go surfing"?
- [A] If the waves are not small, I go surfing.
 - [B] If I go surfing, the waves are not small.
 - [C] If the waves are not small, I do not go surfing.
 - [D] If I do not go surfing, the waves are small.

167. What is the inverse of the statement "If Bob gets hurt, then the team loses the game"?
- [A] Bob gets hurt if the team loses the game.
[B] If Bob does not get hurt, then the team does not lose the game.
[C] If the team does not lose the game, then Bob does not get hurt.
[D] If the team loses the game, then Bob gets hurt.

CHAPTER 4-2

SPECIAL TRIANGLES

168. Vertex angle A of isosceles triangle ABC measures 20° more than three times $m\angle B$. Find $m\angle C$.
169. In isosceles triangle DOG , the measure of the vertex angle is three times the measure of one of the base angles. Which statement about $\triangle DOG$ is true?
- [A] $\triangle DOG$ is an obtuse triangle.
[B] $\triangle DOG$ is a scalene triangle.
[C] $\triangle DOG$ is a right triangle.
[D] $\triangle DOG$ is an acute triangle.
170. In the accompanying diagram, $\triangle ABC$ and $\triangle ABD$ are isosceles triangles with $m\angle CAB = 50$ and $m\angle BDA = 55$. If $AB=AC$ and $AB=BD$, what is $m\angle CBD$?

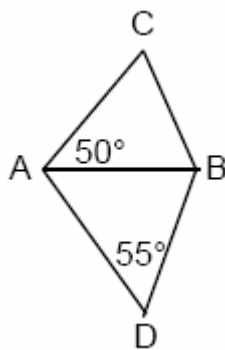

171. In the accompanying diagram of $\triangle BCD$, $\triangle ABC$ is an equilateral triangle and $AD = AB$. What is the value of x , in degrees?

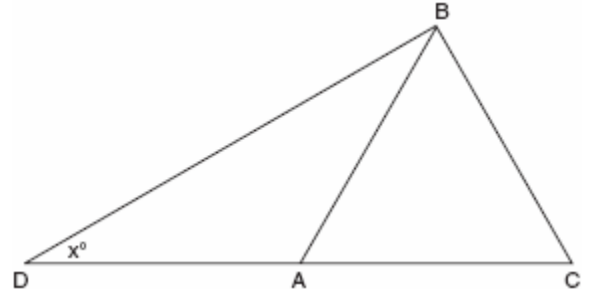

172. Tina wants to sew a piece of fabric into a scarf in the shape of an isosceles triangle, as shown in the accompanying diagram.

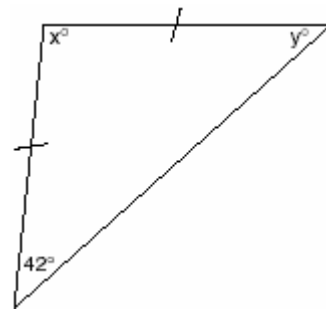

What are the values of x and y ?

- [A] $x = 90$ and $y = 48$
[B] $x = 69$ and $y = 69$
[C] $x = 42$ and $y = 96$
[D] $x = 96$ and $y = 42$

173. The accompanying diagram shows the roof of a house that is in the shape of an isosceles triangle. The vertex angle formed at the peak of the roof is 84° .

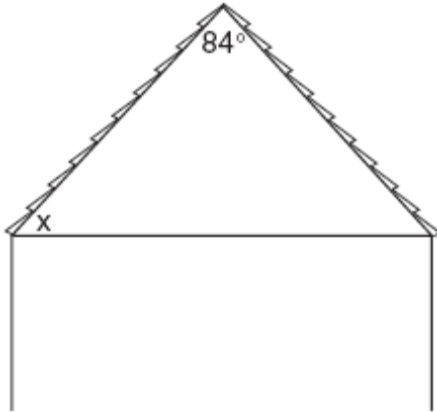

What is the measure of x ?

- [A] 138° [B] 96° [C] 84° [D] 48°
174. In the accompanying diagram of $\triangle ABC$, \overline{AB} is extended through D , $m\angle CBD = 30$, and $\overline{AB} \cong \overline{BC}$.

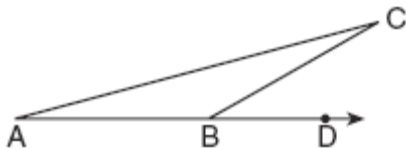

What is the measure of $\angle A$?

- [A] 30° [B] 15° [C] 150° [D] 75°
175. Dylan says that all isosceles triangles are acute triangles. Mary Lou wants to prove that Dylan is *not* correct. Sketch an isosceles triangle that Mary Lou could use to show that Dylan's statement is not true. In your sketch, state the measure of *each* angle of the isosceles triangle.
176. Hersch says if a triangle is an obtuse triangle, then it cannot also be an isosceles triangle. Using a diagram, show that Hersch is incorrect, and indicate the measures of all the angles and sides to justify your answer.

177. The accompanying diagram shows two cables of equal length supporting a pole. Both cables are 14 meters long, and they are anchored to points in the ground that are 14 meters apart.

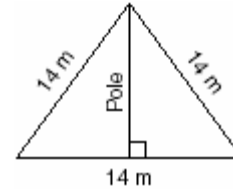

What is the exact height of the pole, in meters?

- [A] $7\sqrt{2}$ [B] 14 [C] $7\sqrt{3}$ [D] 7

CHAPTER 4-4

PROOFS

178. In $\triangle ABC$, D is a point on \overline{AC} such that \overline{BD} is a median. Which statement must be true?
- [A] $\overline{AD} \cong \overline{CD}$ [B] $\angle ABD \cong \angle CBD$
[C] $\triangle ABD \cong \triangle CBD$ [D] $\overline{BD} \perp \overline{AC}$

CHAPTER 4-5

179. In the accompanying diagram, $\triangle ABC$ is *not* isosceles. Prove that if altitude \overline{BD} were drawn, it would *not* bisect \overline{AC} .

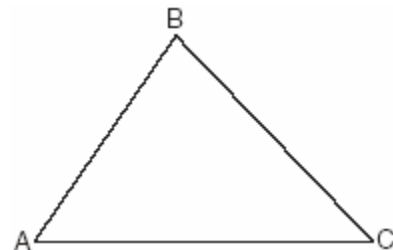

180. Given: parallelogram $ABCD$, diagonal \overline{AC} ,
and \overline{ABE}

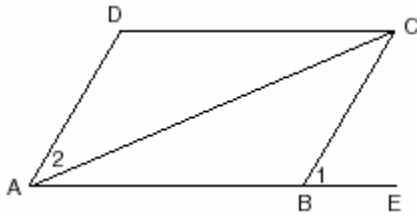

Prove: $m\angle 1 > m\angle 2$

181. Given: $\triangle ABT$, \overline{CBTD} , and $\overline{AB} \perp \overline{CD}$

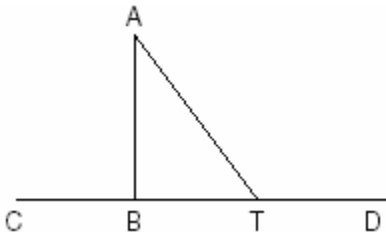

Write an indirect proof to show that \overline{AT} is *not* perpendicular to \overline{CD} .

182. In the accompanying diagram of circle O , \overline{PA} is drawn tangent to the circle at A . Place B on \overline{PA} anywhere between P and A and draw \overline{OA} , \overline{OP} , and \overline{OB} . Prove that \overline{OB} is not perpendicular to \overline{PA} .

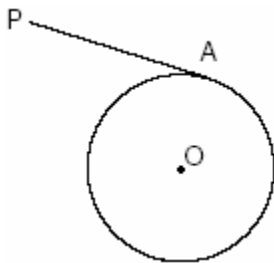

CHAPTER 4-6

TRIANGLE INEQUALITIES

183. If the lengths of two sides of a triangle are 4 and 10, what could be the length of the third side?
[A] 6 [B] 14 [C] 16 [D] 8
184. If two sides of a triangle are 1 and 3, the third side may be
[A] 5 [B] 3 [C] 2 [D] 4
185. Sara is building a triangular pen for her pet rabbit. If two of the sides measure 8 feet and 15 feet, the length of the third side could be
[A] 23 ft [B] 3 ft [C] 7 ft [D] 13 ft
186. The direct distance between city A and city B is 200 miles. The direct distance between city B and city C is 300 miles. Which could be the direct distance between city C and city A ?
[A] 550 miles [B] 350 miles
[C] 50 miles [D] 650 miles
187. Which set can *not* represent the lengths of the sides of a triangle?
[A] {8,8,8} [B] {7,7,12}
[C] {5,5,11} [D] {4,5,6}
188. Which set could *not* represent the lengths of the sides of a triangle?
[A] {5,10,12} [B] {2,5,9}
[C] {3,4,5} [D] {7,9,11}

189. A plot of land is in the shape of rhombus $ABCD$ as shown below.

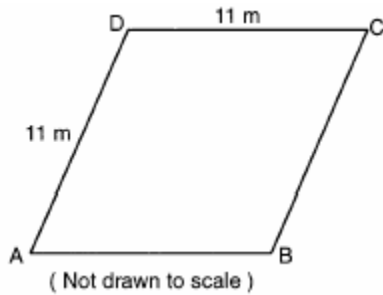

Which can *not* be the length of diagonal AC ?

- [A] 11 m [B] 24 m [C] 4 m [D] 18 m
190. José wants to build a triangular pen for his pet rabbit. He has three lengths of boards already cut that measure 7 feet, 8 feet, and 16 feet. Explain why José cannot construct a pen in the shape of a triangle with sides of 7 feet, 8 feet, and 16 feet.
191. A box contains one 2-inch rod, one 3-inch rod, one 4-inch rod, and one 5-inch rod. What is the maximum number of different triangles that can be made using these rods as sides?

[A] 3 [B] 1 [C] 2 [D] 4

CHAPTER 4-7

LOCUS

192. If point P lies on line ℓ , which diagram represents the locus of points 3 centimeters from point P ?

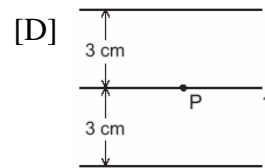
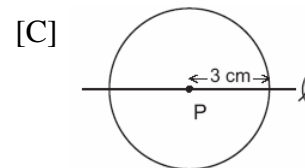
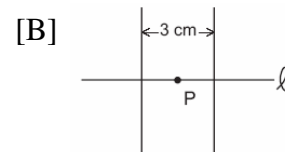
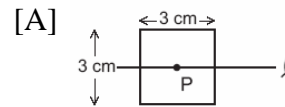

193. Which equation represents the locus of all points 5 units below the x -axis?
- [A] $y = 5$ [B] $x = 5$
[C] $y = -5$ [D] $x = -5$
194. Chantrice is pulling a wagon along a smooth, horizontal street. The path of the center of one of the wagon wheels is best described as
- [A] a line perpendicular to the road
[B] a circle [C] two parallel lines
[D] a line parallel to the road

195. In the accompanying diagram, point P lies 3 centimeters from line l .

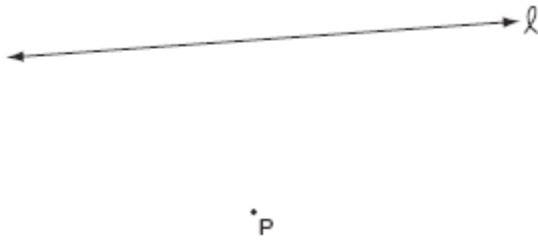

How many points are both 2 centimeters from line l and 1 centimeter from point P ?

- [A] 0 [B] 4 [C] 1 [D] 2
196. In the accompanying diagram, line l_1 is parallel to line l_2 .

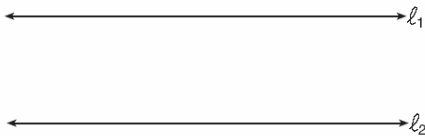

Which term describes the locus of all points that are equidistant from line l_1 and l_2 ?

- [A] circle [B] line
[C] rectangle [D] point
197. The distance between parallel lines l and m is 12 units. Point A is on line l . How many points are equidistant from lines l and m and 8 units from point A .

- [A] 4 [B] 3 [C] 2 [D] 1

198. How many points are equidistant from two parallel lines and also equidistant from two points on one of the lines?

- [A] 2 [B] 4 [C] 1 [D] 3

199. The locus of points equidistant from two sides of an acute scalene triangle is

- [A] a median [B] an angle bisector
[C] the third side [D] an altitude

200. In the coordinate plane, what is the total number of points 5 units from the origin and equidistant from both the x - and y -axes?

- [A] 1 [B] 0 [C] 4 [D] 2

201. What is the total number of points equidistant from two intersecting straight roads and also 300 feet from the traffic light at the center of the intersection?

- [A] 2 [B] 0 [C] 4 [D] 1

202. A treasure map shows a treasure hidden in a park near a tree and a statue. The map indicates that the tree and the statue are 10 feet apart. The treasure is buried 7 feet from the base of the tree and also 5 feet from the base of the statue. How many places are possible locations for the treasure to be buried? Draw a diagram of the treasure map, and indicate with an **X** each possible location of the treasure.

203. Maria's backyard has two trees that are 40 feet apart, as shown in the accompanying diagram. She wants to place lampposts so that the posts are 30 feet from both of the trees. Draw a sketch to show where the lampposts could be placed in relation to the trees. How many locations for the lampposts are possible?

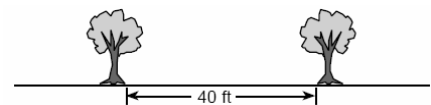

204. Steve has a treasure map, represented in the accompanying diagram, that shows two trees 8 feet apart and a straight fence connecting them. The map states that treasure is buried 3 feet from the fence and equidistant from the two trees.

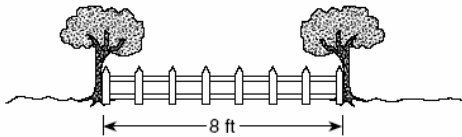

- a Sketch a diagram to show all the places where the treasure could be buried. Clearly indicate in your diagram where the treasure could be buried.
- b What is the distance between the treasure and one of the trees?
205. A triangular park is formed by the intersection of three streets, Bridge Street, Harbor Place, and College Avenue, as shown in the accompanying diagram. A walkway parallel to Harbor Place goes through the park. A time capsule has been buried in the park in a location that is equidistant from Bridge Street and College Avenue and 5 yards from the walkway. Indicate on the diagram with an **X** each possible location where the time capsule could be buried.

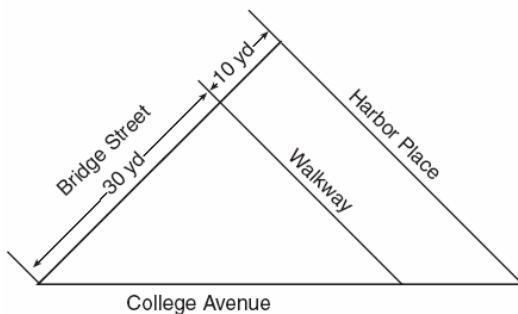

206. Dan is sketching a map of the location of his house and his friend Matthew's house on a set of coordinate axes. Dan locates his house at point $D(0,0)$ and locates Matthews house, which is 6 miles east of Dan's house, at point $M(6,0)$. On the accompanying set of coordinate axes, graph the locus of points equidistant from the two houses. Then write the equation of the locus.

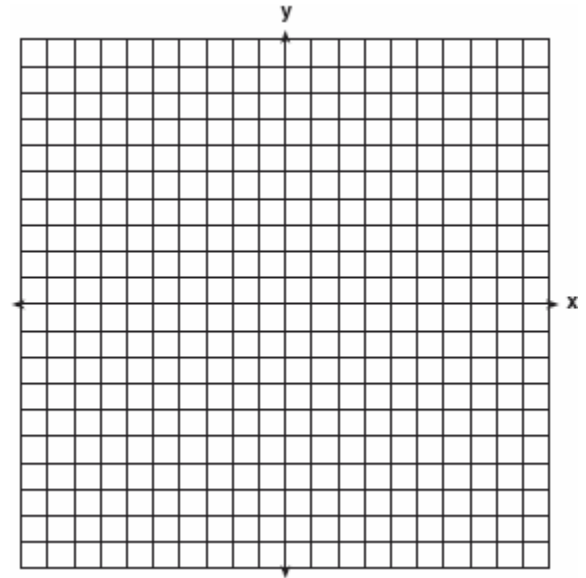

207. Point P is located on \overline{AB} .
- a Describe the locus of points that are
- (1) 3 units from \overline{AB}
 - (2) 5 units from point P
- b How many points satisfy both conditions in part a?

CHAPTER 5-1

PERIMETER AND AREA OF OTHER POLYGONS

208. The Pentagon building in Washington, D.C., is shaped like a regular pentagon. If the length of one side of the Pentagon is represented by $n + 2$, its perimeter would be represented by
- [A] $5n + 10$ [B] $10n$
 [C] $n + 10$ [D] $5n + 2$

209. The lengths of the sides of home plate in a baseball field are represented by the expressions in the accompanying figure.

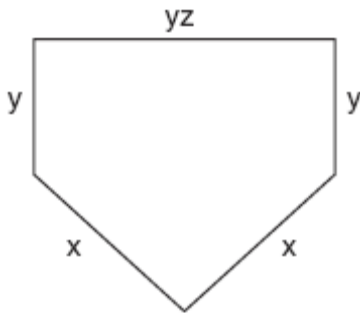

Which expression represents the perimeter of the figure?

- [A] $2x + 3yz$ [B] $x^2 + y^3z$
 [C] $5xyz$ [D] $2x + 2y + yz$
210. An engineer measured the dimensions for a rectangular site by using a wooden pole of unknown length x . The length of the rectangular site is 2 pole measures increased by 3 feet, while the width is 1 pole measure decreased by 4 feet. Write an algebraic representation, in terms of x , for the perimeter of the site.

211. The length of a side of a square window in Jessica's bedroom is represented by $2x - 1$. Which expression represents the area of the window?

- [A] $4x^2 + 1$ [B] $4x^2 + 4x - 1$
 [C] $4x^2 - 4x + 1$ [D] $2x^2 + 1$

212. What is the area of a square whose perimeter is represented by $12x$?

- [A] $12x^2$ [B] $144x^2$
 [C] $6x\sqrt{2}$ [D] $9x^2$

213. The accompanying diagram shows a square with side y inside a square with side x .

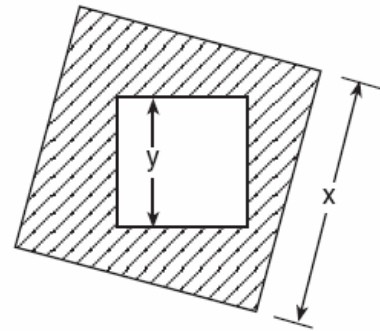

Which expression represents the area of the shaded region?

- [A] $y^2 - x^2$ [B] $x^2 - y^2$
 [C] y^2 [D] x^2
214. Express both the perimeter and the area of the rectangle shown in the accompanying diagram as polynomials in simplest form.

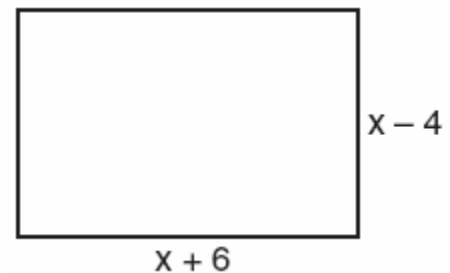

215. In the figure below, the large rectangle, $ABCD$, is divided into four smaller rectangles. The area of rectangle $AEHG = 5x$, the area of rectangle $GHFB = 2x^2$, the area of rectangle $HJCF = 6x$, segment $AG = 5$, and segment $AE = x$.

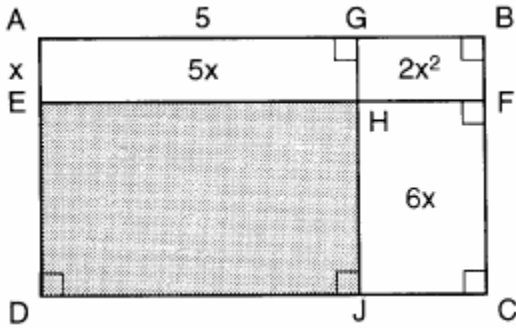

- a Find the area of the shaded region.
b Write an expression for the area of the rectangle $ABCD$ in terms of x .

216. The perimeter of a square is 56. Express the length of a diagonal of the square in simplest radical form.
217. If the area of a square garden is 48 square feet, what is the length, in feet, of one side of the garden?
- [A] $16\sqrt{3}$ [B] $12\sqrt{2}$
[C] $4\sqrt{6}$ [D] $4\sqrt{3}$
218. What is the length of one side of the square whose perimeter has the same numerical value as its area?
- [A] 5 [B] 6 [C] 4 [D] 3

219. A farmer has a rectangular field that measures 100 feet by 150 feet. He plans to increase the area of the field by 20%. He will do this by increasing the length and width by the same amount, x . Which equation represents the area of the new field?

- [A] $(100 + 2x)(150 + x) = 18,000$
[B] $(100 + x)(150 + x) = 15,000$
[C] $(100 + x)(150 + x) = 18,000$
[D] $2(100 + x) + 2(150 + x) = 15,000$

220. In the accompanying figure, $ACDH$ and $BCEF$ are rectangles, $AH = 2$, $GH = 3$, $GF = 4$, and $FE = 5$.

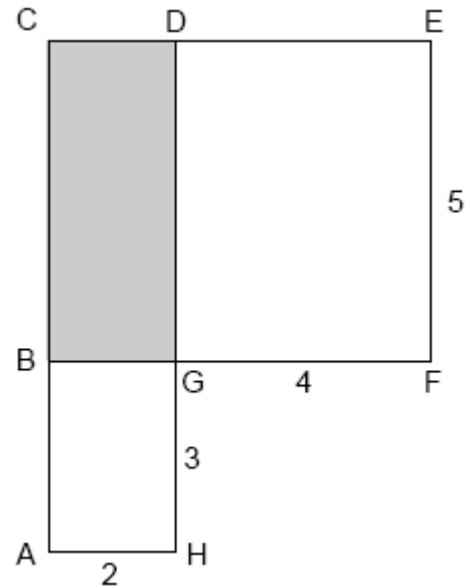

What is the area of $BCDG$?

- [A] 20 [B] 6 [C] 8 [D] 10

221. Jack is building a rectangular dog pen that he wishes to enclose. The width of the pen is 2 yards less than the length. If the area of the dog pen is 15 square yards, how many yards of fencing would he need to completely enclose the pen?

222. The area of the rectangular playground enclosure at South School is 500 square meters. The length of the playground is 5 meters longer than the width. Find the dimensions of the playground, in meters.
[Only an algebraic solution will be accepted.]

223. Javon's homework is to determine the dimensions of his rectangular backyard. He knows that the length is 10 feet more than the width, and the total area is 144 square feet. Write an equation that Javon could use to solve this problem. Then find the dimensions, in feet, of his backyard.

224. A rectangular park is three blocks longer than it is wide. The area of the park is 40 square blocks. If w represents the width, write an equation in terms of w for the area of the park. Find the length and the width of the park.

225. Mr. Santana wants to carpet exactly half of his rectangular living room. He knows that the perimeter of the room is 96 feet and that the length of the room is 6 feet longer than the width. How many square feet of carpeting does Mr. Santana need?

226. Kerry is planning a rectangular garden that has dimensions of 4 feet by 6 feet. Kerry wants one-half of the garden to have roses, and she says that the rose plot will have dimensions of 2 feet by 3 feet. Is she correct? Explain.

227. Determine the area, in square feet, of the *smallest* square that can contain a circle with a radius of 8 feet.

228. Keesha wants to tile the floor shown in the accompanying diagram. If each tile measures 1 foot by 1 foot and costs \$2.99, what will be the total cost, including an 8% sales tax, for tiling the floor?

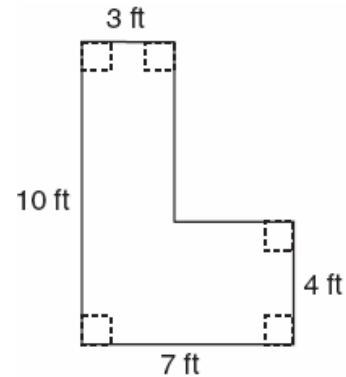

229. A rectangular garden is going to be planted in a person's rectangular backyard, as shown in the accompanying diagram. Some dimensions of the backyard and the width of the garden are given. Find the area of the garden to the *nearest square foot*.

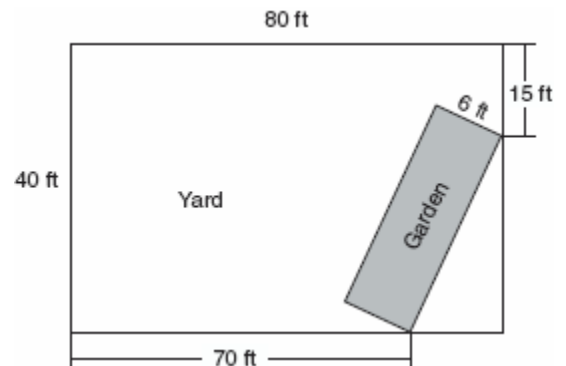

230. Mr. James wanted to plant a garden that would be in the shape of a rectangle. He was given 80 feet of fencing to enclose his garden. He wants the length to be 10 feet more than twice the width. What are the dimensions, in feet, for a rectangular garden that will use exactly 80 feet of fencing?

231. In the accompanying diagram, the perimeter of $\triangle MNO$ is equal to the perimeter of square ABCD. If the sides of the triangle are represented by $4x + 4$, $5x - 3$, and 17, and one side of the square is represented by $3x$, find the length of a side of the square.

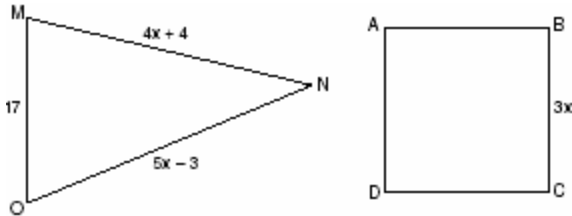

232. Manuel plans to install a fence around the perimeter of his yard. His yard is shaped like a square and has an area of 40,000 square feet. The company that he hires charges \$2.50 per foot for the fencing and \$50.00 for the installation fee. What will be the cost of the fence, in dollars?
233. A homeowner wants to increase the size of a rectangular deck that now measures 15 feet by 20 feet, but building code laws state that a homeowner cannot have a deck larger than 900 square feet. If the length and the width are to be increased by the same amount, find, to the *nearest tenth*, the maximum number of feet that the length of the deck may be increased in size legally.
234. Chad had a garden that was in the shape of a rectangle. Its length was twice its width. He decided to make a new garden that was 2 feet longer and 2 feet wider than his first garden. If x represents the original width of the garden, which expression represents the difference between the area of his new garden and the area of the original garden?
- [A] $x^2 + 3x + 2$ [B] $6x + 4$
[C] 8 [D] $2x^2$

235. A small, open-top packing box, similar to a shoebox without a lid, is three times as long as it is wide, and half as high as it is long. Each square inch of the bottom of the box costs \$0.008 to produce, while each square inch of any side costs \$0.003 to produce. Write a function for the cost of the box described above. Using this function, determine the dimensions of a box that would cost \$0.69 to produce.

CHAPTER 5-2

PERIMETER AND AREA OF TRIANGLES

236. The second side of a triangle is two more than the first side, and the third side is three less than the first side. Which expression represents the perimeter of the triangle?
- [A] $x^2 - x - 6$ [B] $2x - 1$
[C] $x + 5$ [D] $3x - 1$
237. If the base of a triangle is represented by $x + 4$ and the height is represented by $2x$, which expression represents the area of the triangle?
- [A] $\frac{1}{2}(x + 4)(2x)$ [B] $(x + 4)(2x)$
[C] $\frac{1}{2}((x + 4) + (2x))$
[D] $(x + 4) + (2x)$

238. The plot of land illustrated in the accompanying diagram has a perimeter of 34 yards. Find the length, in yards, of *each* side of the figure. Could these measures actually represent the measures of the sides of a triangle? Explain your answer.

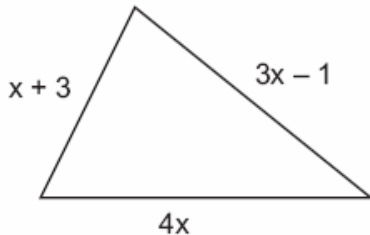

239. What is the perimeter of an equilateral triangle whose height is $2\sqrt{3}$?
- [A] 12 [B] 6 [C] $12\sqrt{3}$ [D] $6\sqrt{3}$
240. The perimeter of an isosceles triangle is 71 centimeters. The measure of one of the sides is 22 centimeters. What are all the possible measures of the other two sides?
241. Sean knows the length of the base, b , and the area, A , of a triangular window in his bedroom. Which formula could he use to find the height, h , of this window?
- [A] $h = \frac{A}{2b}$ [B] $h = 2A - b$
- [C] $h = (2A)(b)$ [D] $h = \frac{2A}{b}$
242. If the midpoints of the sides of a triangle are connected, the area of the triangle formed is what part of the area of the original triangle?

- [A] $\frac{1}{4}$ [B] $\frac{1}{3}$ [C] $\frac{1}{2}$ [D] $\frac{3}{8}$

243. On the accompanying set of axes, graph and label the following lines:

$$y = 5$$

$$x = -4$$

$$y = \frac{5}{4}x + 5$$

Calculate the area, in square units, of the triangle formed by the three points of intersection.

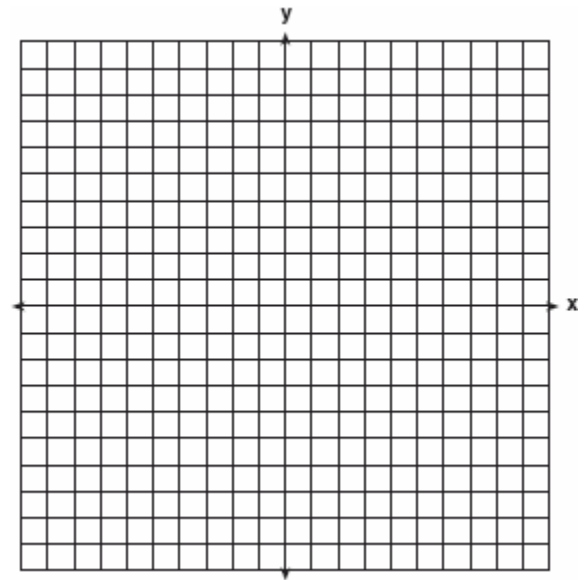

244. Mr. Gonzalez owns a triangular plot of land BCD with $DB = 25$ yards and $BC = 16$ yards. He wishes to purchase the adjacent plot of land in the shape of right triangle ABD , as shown in the accompanying diagram, with $AD = 15$ yards. If the purchase is made, what will be the total number of square yards in the area of his plot of land, $\triangle ACD$?

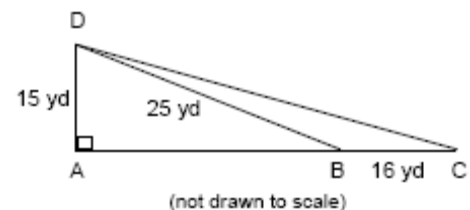

245. The plan of a parcel of land is represented by trapezoid $ABCD$ in the accompanying diagram. If the area of $\triangle ABE$ is 600 square feet, find the minimum number of feet of fence needed to completely enclose the entire parcel of land, $ABCD$.

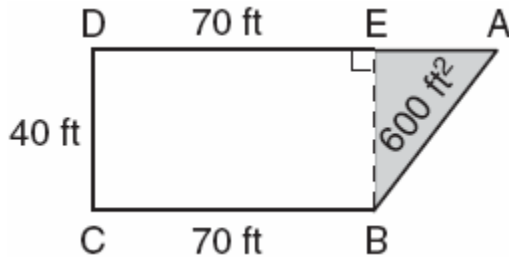

246. On the accompanying grid, draw and label quadrilateral $ABCD$ with points $A(1,2)$, $B(6,1)$, $C(7,6)$, and $D(3,7)$. On the same set of axes, plot and label quadrilateral $A'B'C'D'$, the reflection of quadrilateral $ABCD$ in the y -axis. Determine the area, in square units, of quadrilateral $A'B'C'D'$.

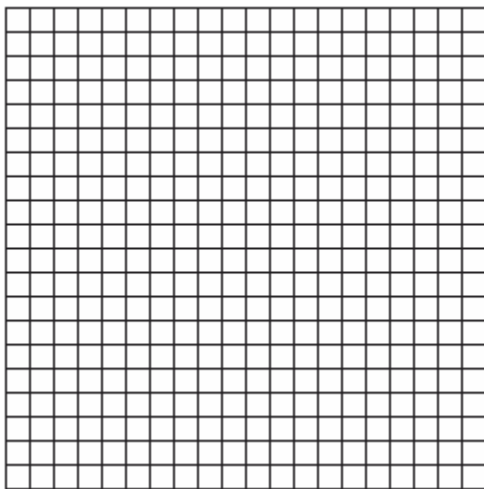

CHAPTER 5-4

247. If the perimeter of an equilateral triangle is 18, the length of the altitude of this triangle is
- [A] 3 [B] $3\sqrt{3}$ [C] 6 [D] $6\sqrt{3}$

248. A garden in the shape of an equilateral triangle has sides whose lengths are 10 meters. What is the area of the garden?

- [A] $50\sqrt{3} m^2$ [B] $50 m^2$
[C] $25\sqrt{3} m^2$ [D] $25 m^2$

CHAPTER 5-5

PERIMETER AND AREA OF OTHER POLYGONS

249. The equation $A = \frac{1}{2}(12)(3+7)$ is used to find the area of a trapezoid. Which calculation would *not* result in the correct area?

- [A] $\frac{12(3+7)}{2}$ [B] $\frac{12}{2} \times \frac{10}{2}$
[C] $0.5(12)(10)$ [D] $6(3+7)$

CHAPTER 5-6

250. A picnic table in the shape of a regular octagon is shown in the accompanying diagram. If the length of \overline{AE} is 6 feet, find the length of one side of the table to the nearest tenth of a foot, and find the area of the table's surface to the nearest tenth of a square foot.

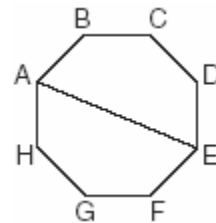

CHAPTER 5-7

CIRCUMFERENCE AND AREA

251. What is the approximate circumference of a circle with radius 3?
- [A] 18.85 [B] 9.42
[C] 28.27 [D] 7.07
252. What is the diameter of a circle whose circumference is 5?
- [A] $\frac{2.5}{\pi^2}$ [B] $\frac{5}{\pi}$ [C] $\frac{2.5}{\pi}$ [D] $\frac{5}{\pi^2}$
253. A wheel has a radius of 5 feet. What is the minimum number of *complete* revolutions that the wheel must make to roll at least 1,000 feet?
254. To measure the length of a hiking trail, a worker uses a device with a 2-foot-diameter wheel that counts the number of revolutions the wheel makes. If the device reads 1,100.5 revolutions at the end of the trail, how many miles long is the trail, to the *nearest tenth of a mile*?
255. Every time the pedals go through a 360° rotation on a certain bicycle, the tires rotate three times. If the tires are 24 inches in diameter, what is the minimum number of complete rotations of the pedals needed for the bicycle to travel at least 1 mile?
- [A] 12 [B] 5,280 [C] 561 [D] 281
256. Ileana buys a large circular pizza that is divided into eight equal slices. She measures along the outer edge of the crust from one piece and finds it to be $5\frac{1}{2}$ inches. What is the diameter of the pizza to the *nearest inch*?
- [A] 7 [B] 8 [C] 4 [D] 14

257. A ball is rolling in a circular path that has a radius of 10 inches, as shown in the accompanying diagram. What distance has the ball rolled when the subtended arc is 54° ? Express your answer to the *nearest hundredth of an inch*.

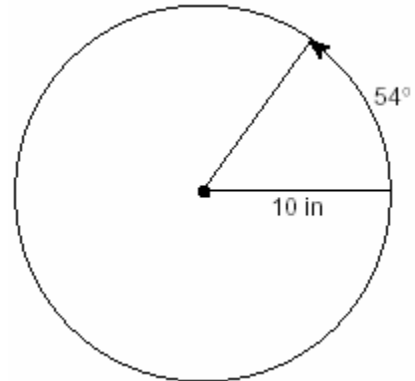

258. Cities H and K are located on the same line of longitude and the difference in the latitude of these cities is 9° , as shown in the accompanying diagram. If Earth's radius is 3,954 miles, how many miles north of city K is city H along arc HK ? Round your answer to the *nearest tenth of a mile*.

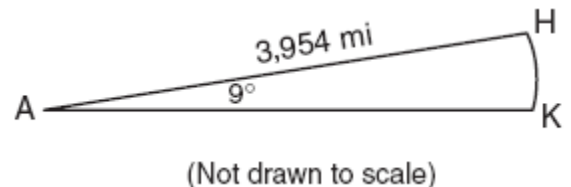

259. The accompanying diagram shows the path of a cart traveling on a circular track of radius 2.40 meters. The cart starts at point A and stops at point B , moving in a counterclockwise direction. What is the length of minor arc AB , over which the cart traveled, to the *nearest tenth of a meter*?

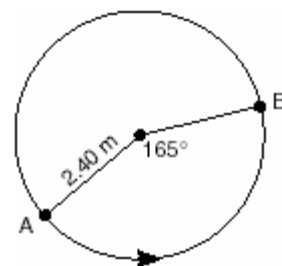

260. Kathy and Tami are at point A on a circular track that has a radius of 150 feet, as shown in the accompanying diagram. They run counterclockwise along the track from A to S , a distance of 247 feet. Find, to the *nearest degree*, the measure of minor arc AS .

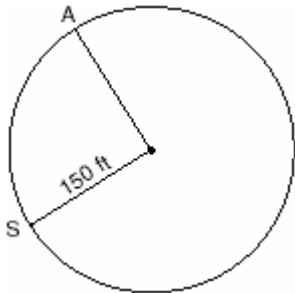

261. As shown in the accompanying diagram, a dial in the shape of a semicircle has a radius of 4 centimeters. Find the measure of θ , in radians, when the pointer rotates to form an arc whose length is 1.38 centimeters.

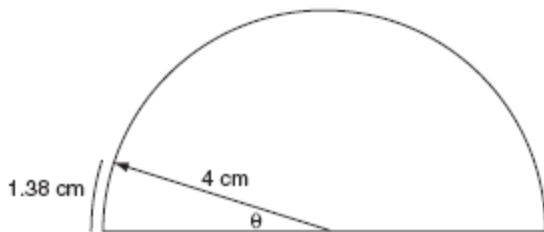

264. A circular garden has a diameter of 12 feet. How many bags of topsoil must Linda buy to cover the garden if one bag covers an area of 3 square feet?

[A] 38 [B] 13 [C] 40 [D] 151

265. In the accompanying diagram, right triangle ABC is inscribed in circle O , diameter $AB = 26$, and $CB = 10$. Find, to the *nearest square unit*, the area of the shaded region.

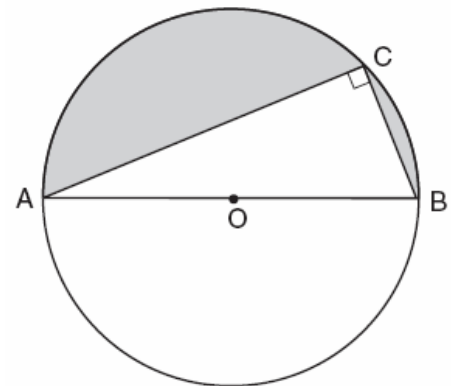

266. As shown in the accompanying diagram, radio station KMA is increasing its radio listening radius from 40 miles to 50 miles. How many additional square miles of listening area, to the *nearest tenth*, will the radio station gain?

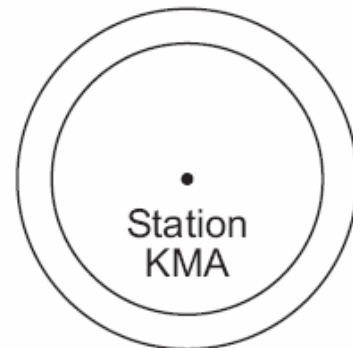

CHAPTER 5-8

262. If the circumference of a circle is 10π inches, what is the area, in square inches, of the circle?
- [A] 100π [B] 10π
[C] 50π [D] 25π
263. A dog is tied with a rope to a stake in the ground. The length of the rope is 5 yards. What is the area, in square yards, in which the dog can roam?
- [A] 25π [B] 25 [C] 20 [D] 10π

267. Virginia has a circular rug on her square living room floor, as represented in the accompanying diagram. If her entire living room floor measures 100 square feet, what is the area of the part of the floor covered by the rug?

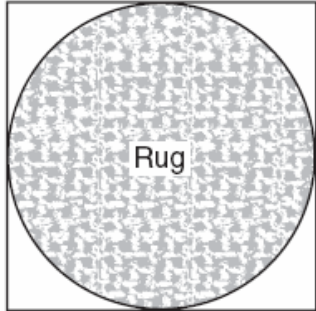

268. In the accompanying diagram, a circle with radius 4 is inscribed in a square.

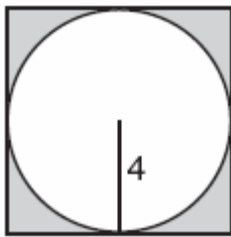

What is the area of the shaded region?

- [A] $64 - 16\pi$ [B] $16 - 16\pi$
 [C] $16 - 8\pi$ [D] $64\pi - 8\pi$

269. If asphalt pavement costs \$0.78 per square foot, determine, to the *nearest cent*, the cost of paving the shaded circular road with center O, an outside radius of 50 feet, and an inner radius of 36 feet, as shown in the accompanying diagram.

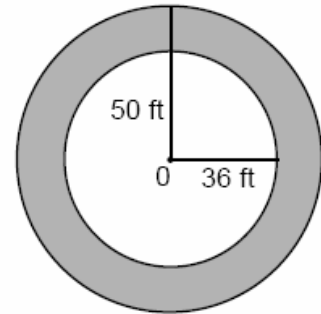

270. A target shown in the accompanying diagram consists of three circles with the same center. The radii of the circles have lengths of 3 inches, 7 inches, and 9 inches.

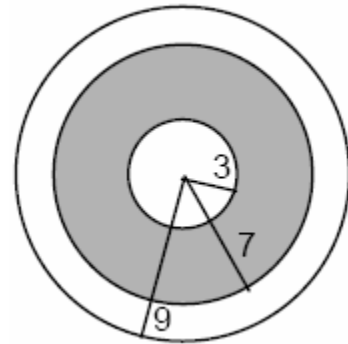

- a* What is the area of the shaded region to the *nearest tenth of a square inch*?
b To the *nearest percent*, what percent of the target is shaded?

271. Mr. Petri has a rectangular plot of land with length = 20 feet and width = 10 feet. He wants to design a flower garden in the shape of a circle with two semicircles at each end of the center circle, as shown in the accompanying diagram. He will fill in the shaded area with wood chips. If one bag of wood chips covers 5 square feet, how many bags must he buy?

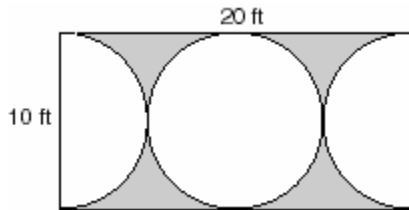

272. Cerise waters her lawn with a sprinkler that sprays water in a circular pattern at a distance of 15 feet from the sprinkler. The sprinkler head rotates through an angle of 300° , as shown by the shaded area in the accompanying diagram.

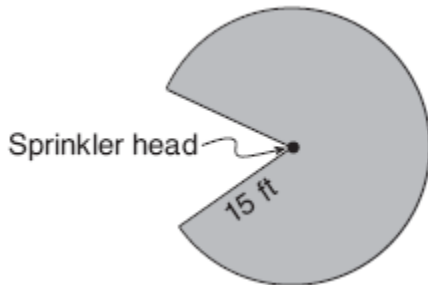

What is the area of the lawn, to the *nearest square foot*, that receives water from this sprinkler?

- [A] 79 [B] 94 [C] 707 [D] 589
273. The circumference of a circular plot of land is increased by 10%. What is the best estimate of the total percentage that the area of the plot increased?
- [A] 25% [B] 10% [C] 31% [D] 21%

CHAPTER 6-1

CLASSIFYING SOLIDS

274. Which piece of paper can be folded into a pyramid?

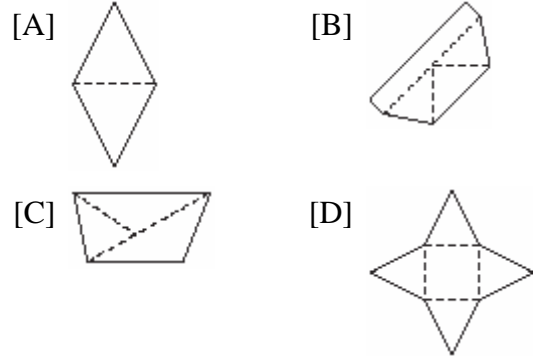

CHAPTER 6-2

275. A roll of candy is shown in the accompanying diagram.



The shape of the candy is best described as a

- [A] rectangular solid [B] cone
[C] cylinder [D] pyramid

CHAPTER 6-3

276. Triangle ABC represents a metal flag on pole AD , as shown in the accompanying diagram. On a windy day the triangle spins around the pole so fast that it looks like a three-dimensional shape.

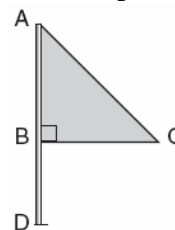

Which shape would the spinning flag create?

- [A] right circular cylinder [B] cone
[C] sphere [D] pyramid

CHAPTER 6-4

VOLUME

277. Which diagram represents the figure with the greatest volume?

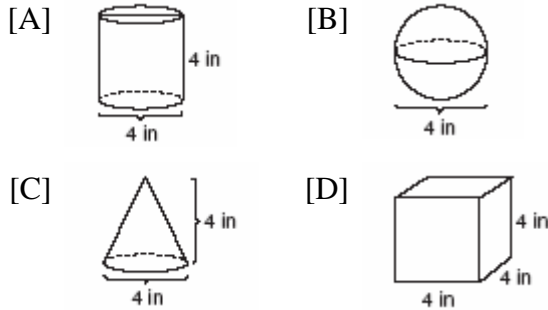

278. A box in the shape of a cube has a volume of 64 cubic inches. What is the length of a side of the box?

- [A] 16 in [B] 4 in
[C] 8 in [D] $21\frac{1}{3}$ in

279. The volume of a cube is 64 cubic inches. Its total surface area, in square inches, is

- [A] 96 [B] 16 [C] 48 [D] 576

280. A storage container in the shape of a right circular cylinder is shown in the accompanying diagram.

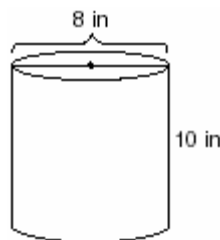

What is the volume of this container, to the nearest hundredth?

- [A] 251.33 in^3 [B] 125.66 in^3
[C] 502.65 in^3 [D] 56.55 in^3

281. If the length of a rectangular prism is doubled, its width is tripled, and its height remains the same, what is the volume of the new rectangular prism?

- [A] triple the original volume
[B] nine times the original volume
[C] six times the original volume
[D] double the original volume

282. A planned building was going to be 100 feet long, 75 feet deep, and 30 feet high. The owner decides to increase the volume of the building by 10% without changing the dimensions of the depth and the height. What will be the new length of this building?

- [A] 110 ft [B] 108 ft
[C] 112 ft [D] 106 ft

283. A cardboard box has length $x - 2$, width $x + 1$, and height $2x$.

- a Write an expression, in terms of x , to represent the volume of the box.
b If $x = 8$ centimeters, what is the number of cubic centimeters in the volume of the box?

284. Deborah built a box by cutting 3-inch squares from the corners of a rectangular sheet of cardboard, as shown in the accompanying diagram, and then folding the sides up. The volume of the box is 150 cubic inches, and the longer side of the box is 5 inches more than the shorter side. Find the number of inches in the shorter side of the *original* sheet of cardboard.

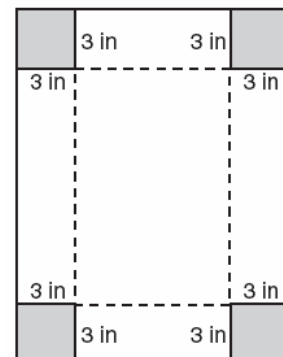

285. The volume of a rectangular pool is 1,080 cubic meters. Its length, width, and depth are in the ratio 10:4:1. Find the number of meters in each of the three dimensions of the pool.
286. A fish tank with a rectangular base has a volume of 3,360 cubic inches. The length and width of the tank are 14 inches and 12 inches, respectively. Find the height, in inches, of the tank.
287. The dimensions of a brick, in inches, are 2 by 4 by 8. How many such bricks are needed to have a total volume of exactly 1 cubic foot?
288. Tina's preschool has a set of cardboard building blocks, each of which measures 9 inches by 9 inches by 4 inches. How many of these blocks will Tina need to build a wall 4 inches thick, 3 feet high, and 12 feet long?
289. Tracey has two empty cube-shaped containers with sides of 5 inches and 7 inches, as shown in the accompanying diagram. She fills the smaller container completely with water and then pours all the water from the smaller container into the larger container. How deep, to the *nearest tenth of an inch*, will the water be in the larger container?

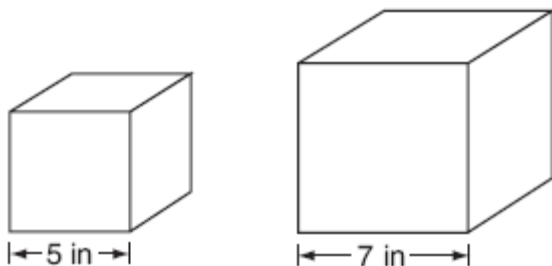

290. Tamika has a hard rubber ball whose circumference measures 13 inches. She wants to box it for a gift but can only find cube-shaped boxes of sides 3 inches, 4 inches, 5 inches, or 6 inches. What is the *smallest* box that the ball will fit into with the top on?

291. In the accompanying diagram, a rectangular container with the dimensions 10 inches by 15 inches by 20 inches is to be filled with water, using a cylindrical cup whose radius is 2 inches and whose height is 5 inches. What is the maximum number of full cups of water that can be placed into the container without the water overflowing the container?

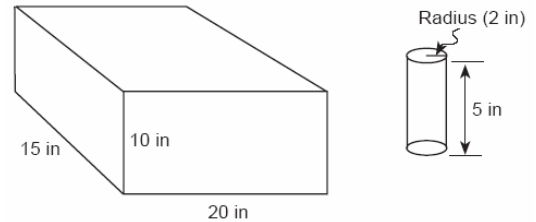

292. As shown in the accompanying diagram, the length, width, and height of Richard's fish tank are 24 inches, 16 inches, and 18 inches, respectively. Richard is filling his fish tank with water from a hose at the rate of 500 cubic inches per minute. How long will it take, to the *nearest minute*, to fill the tank to a depth of 15 inches?

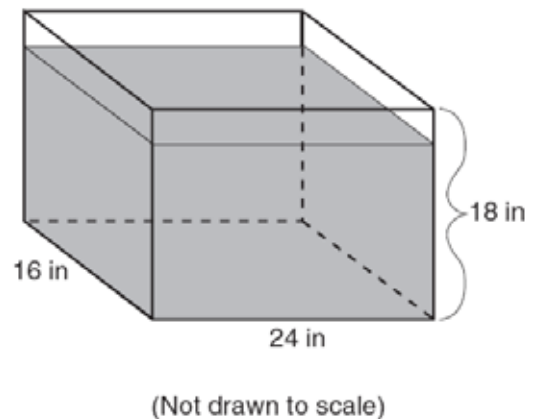

293. A rectangular piece of cardboard is to be formed into an uncovered box. The piece of cardboard is 2 centimeters longer than it is wide. A square that measures 3 centimeters on a side is cut from each corner. When the sides are turned up to form the box, its volume is 765 cubic centimeters. Find the dimensions, in centimeters, of the original piece of cardboard.

294. Denise is designing a storage box in the shape of a cube. Each side of the box has a length of 10 inches. She needs more room and decides to construct a larger box in the shape of a cube with a volume of 2,000 cubic inches. By how many inches, to the *nearest tenth*, should she *increase* the length of each side of the original box?

297. A square dartboard is represented in the accompanying diagram. The entire dartboard is the first quadrant from $x = 0$ to 6 and from $y = 0$ to 6. A triangular region on the dartboard is enclosed by the graphs of the equations $y = 2$, $x = 6$, and $y = x$. Find the probability that a dart that randomly hits the dartboard will land in the triangular region formed by the three lines.

CHAPTER 6-8

GEOMETRIC PROBABILITY

295. At a school fair, the spinner represented in the accompanying diagram is spun twice.

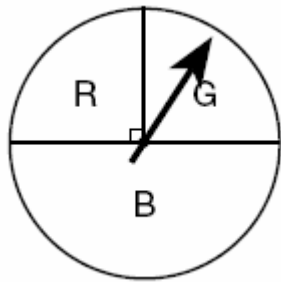

What is the probability that it will land in section G the first time and then in section B the second time?

- [A] $\frac{1}{8}$ [B] $\frac{1}{16}$ [C] $\frac{1}{4}$ [D] $\frac{1}{2}$
296. The accompanying diagram shows a square dartboard. The side of the dartboard measures 30 inches. The square shaded region at the center has a side that measures 10 inches. If darts thrown at the board are equally likely to land anywhere on the board, what is the theoretical probability that a dart does *not* land in the shaded region?

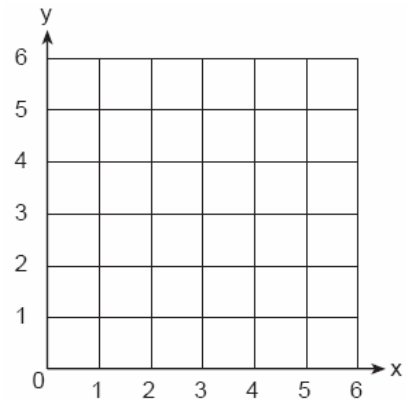
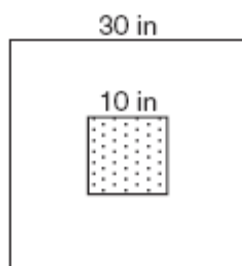

CHAPTER 7-1

NY LESSON 2

ANGLES INVOLVING PARALLEL LINES

298. In the accompanying figure, what is one pair of alternate interior angles?

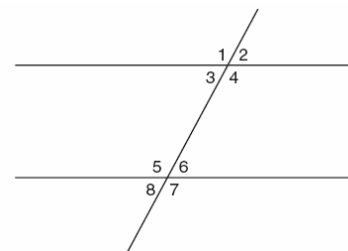

- [A] $\angle 4$ and $\angle 6$ [B] $\angle 4$ and $\angle 5$
[C] $\angle 1$ and $\angle 2$ [D] $\angle 6$ and $\angle 8$

299. In the accompanying diagram, lines a and b are parallel, and lines c and d are transversals.

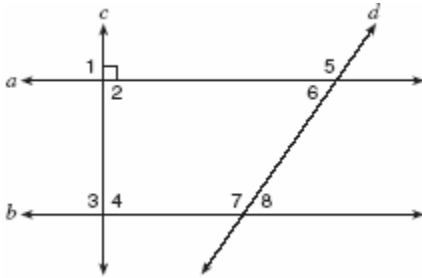

Which angle is congruent to angle 8?

- [A] 4 [B] 3 [C] 5 [D] 6
300. The accompanying diagram shows a football player crossing the 20-yard line at an angle of 30° and continuing along the same path.

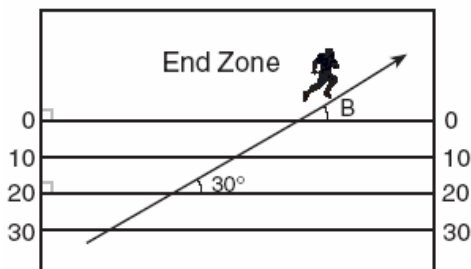

What is the measure of angle B, where the player crosses into the end zone?

- [A] 30° [B] 150° [C] 60° [D] 180°

301. In the accompanying diagram, line ℓ is parallel to line m , and line t is a transversal.

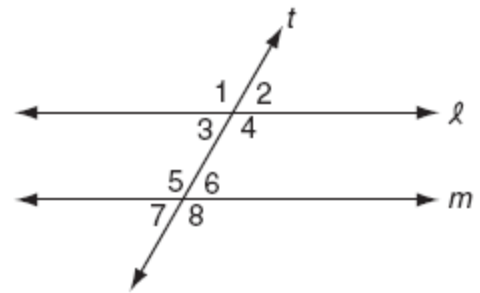

Which must be a true statement?

- [A] $m\angle 1 + m\angle 8 = 180$
 [B] $m\angle 3 + m\angle 6 = 180$
 [C] $m\angle 1 + m\angle 4 = 180$
 [D] $m\angle 2 + m\angle 5 = 180$
302. The accompanying diagram shows two parallel roads, Hope Street and Grand Street, crossed by a transversal road, Broadway.

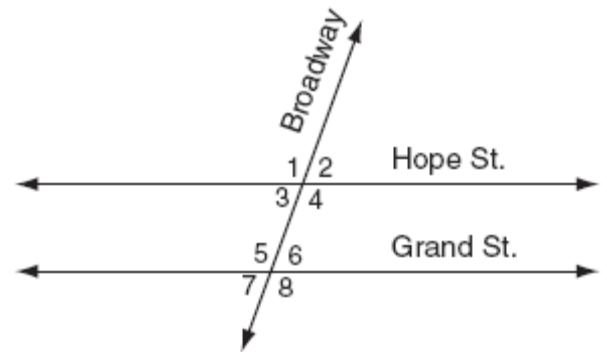

If $m\angle 1 = 110$, what is the measure of $\angle 7$?

- [A] 40° [B] 110° [C] 70° [D] 180°

303. In the accompanying diagram, parallel lines \overline{AB} and \overline{CD} are intersected by transversal \overline{EF} at points X and Y , and $m\angle FYD = 123^\circ$. Find $m\angle AXY$.

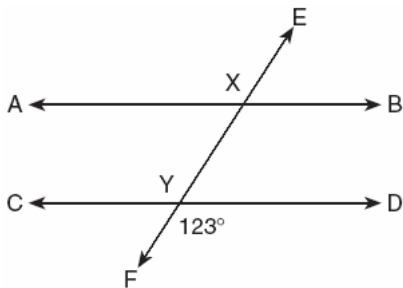

304. In the accompanying diagram, parallel lines \overline{AB} and \overline{CD} are intersected by transversal \overline{EF} at points G and H , respectively, $m\angle AGH = x + 15$, and $m\angle GHD = 2x$.

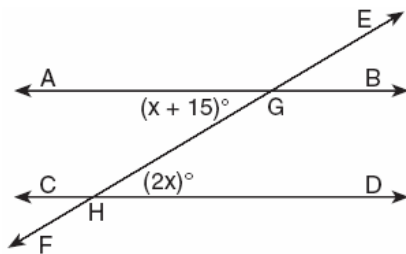

Which equation can be used to find the value of x ?

- [A] $2x + x + 15 = 90$
 [B] $2x + x + 15 = 180$
 [C] $2x(x + 15) = 0$ [D] $2x = x + 15$
305. In the accompanying diagram, line m is parallel to line p , line t is a transversal, $m\angle a = 3x + 12$, and $m\angle b = 2x + 13$. Find the value of x .

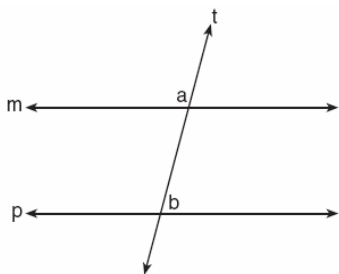

306. Two parallel roads, Elm Street and Oak Street, are crossed by a third, Walnut Street, as shown in the accompanying diagram. Find the number of degrees in the acute angle formed by the intersection of Walnut Street and Elm Street.

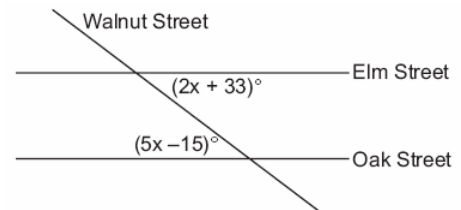

307. In the accompanying diagram, $\overleftrightarrow{CD} \parallel \overleftrightarrow{EF}$, \overleftrightarrow{AB} is a transversal, $m\angle DGH = 2x$, and $m\angle FHB = 5x - 51$. Find the measure, in degrees, of $\angle BHE$.

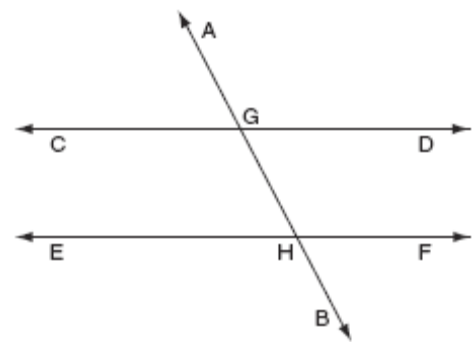

308. The accompanying diagram shows two parallel streets, Main Street and Brooks Road, intersected by Jay Street. The obtuse angle that Jay Street forms with Brooks Road is three times the measure of the acute angle that Jay Street forms with Main Street.

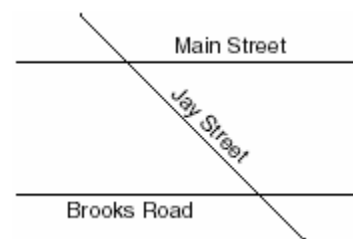

What is the measure of the acute angle formed by Jay Street and Main Street?

- [A] 60° [B] 135° [C] 45° [D] 90°

CHAPTER 8-4

PROOFS

309. In the accompanying diagram of $\triangle ABC$,

$$\overline{AB} \cong \overline{AC}, \overline{BD} = \frac{1}{3}\overline{BA}, \text{ and } \overline{CE} = \frac{1}{3}\overline{CA}.$$

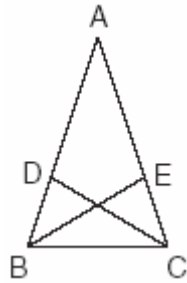

Triangle EBC can be proved congruent to triangle DCB by

- [A] $SSS \cong SSS$ [B] $HL \cong HL$
[C] $ASA \cong ASA$ [D] $SAS \cong SAS$

310. In the accompanying diagram, $\overline{CA} \perp \overline{AB}$, $\overline{ED} \perp \overline{DF}$, $\overline{ED} \parallel \overline{AB}$, $\overline{CE} \cong \overline{BF}$, $\overline{AB} \cong \overline{ED}$ and $m\angle CAB = m\angle FDE = 90$.

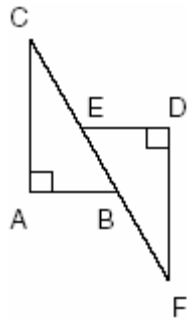

Which statement would *not* be used to prove $\triangle ABC \cong \triangle DEF$?

- [A] $SAS \cong SAS$ [B] $AAS \cong AAS$
[C] $HL \cong HL$ [D] $SSS \cong SSS$

311. In the accompanying diagram of parallelogram $ABCD$, $\overline{DE} \cong \overline{BF}$.

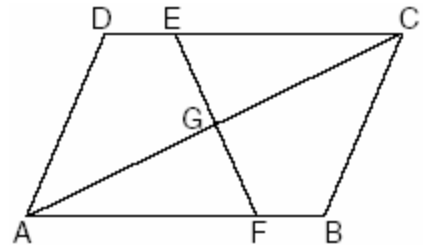

Triangle EGC can be proved congruent to triangle FGA by

- [A] $SSA \cong SSA$ [B] $AAA \cong AAA$
[C] $AAS \cong AAS$ [D] $HL \cong HL$

312. In the accompanying diagram, \overline{HK} bisects \overline{IL} and $\angle H \cong \angle K$.

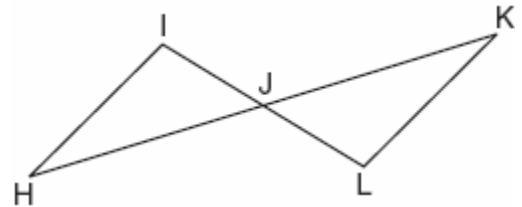

What is the most direct method of proof that could be used to prove $\triangle HIJ \cong \triangle KLJ$?

- [A] $ASA \cong ASA$ [B] $SAS \cong SAS$
[C] $HL \cong HL$ [D] $AAS \cong AAS$

313. Which condition does *not* prove that two triangles are congruent?

- [A] $SAS \cong SAS$ [B] $SSA \cong SSA$
[C] $SSS \cong SSS$ [D] $ASA \cong ASA$

314. Which statements could be used to prove that $\triangle ABC$ and $\triangle A'B'C'$ are congruent?

- [A] $\angle A \cong \angle A'$, $\overline{AC} \cong \overline{A'C'}$, and $\overline{BC} \cong \overline{B'C'}$
[B] $\overline{AB} \cong \overline{A'B'}$, $\angle A \cong \angle A'$, and $\angle C \cong \angle C'$
[C] $\angle A \cong \angle A'$, $\angle B \cong \angle B'$, and $\angle C \cong \angle C'$
[D] $\overline{AB} \cong \overline{A'B'}$, $\overline{BC} \cong \overline{B'C'}$, and $\angle A \cong \angle A'$

315. Given: parallelogram $FLSH$, diagonal \overline{FGAS} , $\overline{LG} \perp \overline{FS}$, $\overline{HA} \perp \overline{FS}$

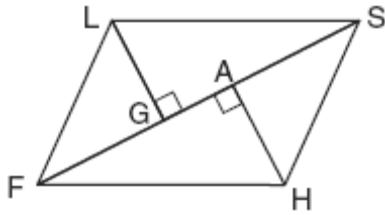

Prove: $\triangle LGS \cong \triangle HAF$

316.

Complete the partial proof below for the accompanying diagram by providing reasons for steps 3, 6, 8, and 9.

- Given: \overline{AFCD}
 $\overline{AB} \perp \overline{BC}$
 $\overline{DE} \perp \overline{EF}$
 $\overline{BC} \parallel \overline{FE}$
 $\overline{AB} = \overline{DE}$

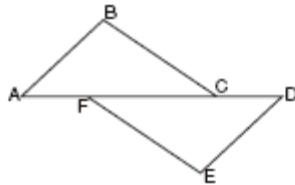

Prove: $\overline{AC} = \overline{FD}$

Statements	Reasons
1 \overline{AFCD}	1 Given
2 $\overline{AB} \perp \overline{BC}$, $\overline{DE} \perp \overline{EF}$	2 Given
3 $\angle B$ and $\angle E$ are right angles.	3 _____ _____
4 $\angle B = \angle E$	4 All right angles are congruent.
5 $\overline{BC} \parallel \overline{FE}$	5 Given
6 $\angle BCA = \angle FED$	6 _____ _____
7 $\overline{AB} = \overline{DE}$	7 Given
8 $\triangle ABC \cong \triangle DEF$	8 _____ _____ _____
9 $\overline{AC} = \overline{FD}$	9 _____ _____

CHAPTER 9-1

SPECIAL QUADRILATERALS

317. In the accompanying diagram of parallelogram $ABCD$, diagonals \overline{AC} and \overline{DB} intersect at E , $AE = 3x - 4$, and $EC = x + 12$.

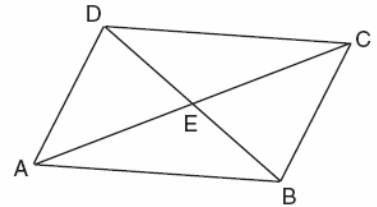

What is the value of x ?

- [A] 40 [B] 16 [C] 20 [D] 8

318. In the accompanying diagram of parallelogram $ABCD$, diagonals \overline{AC} and \overline{BD} intersect at E , $BE = \frac{2}{3}x$, and $ED = x - 10$.

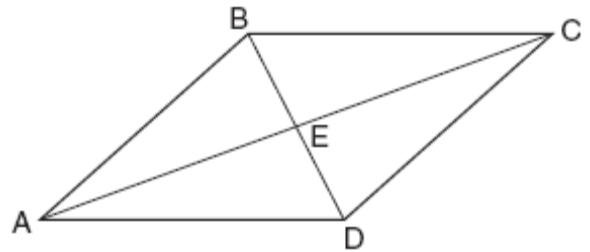

What is the value of x ?

- [A] 30 [B] -6 [C] 6 [D] -30

319. In the accompanying diagram of parallelogram $ABCD$, $m\angle A = (2x + 10)$ and $m\angle B = 3x$. Find the number of degrees in $m\angle B$.

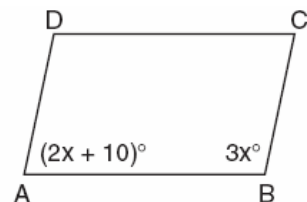

320. In the accompanying diagram of parallelogram $ABCD$, $m\angle B = 5x$ and $m\angle C = 2x + 12$. Find the number of degrees in $\angle D$.

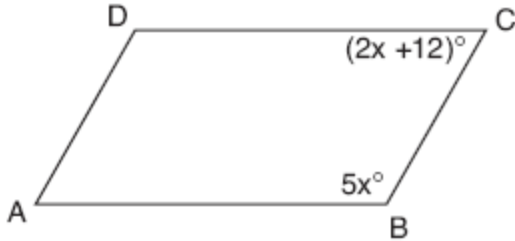

321. The measures of two consecutive angles of a parallelogram are in the ratio 5:4. What is the measure of an obtuse angle of the parallelogram?
[A] 100° [B] 80° [C] 20° [D] 160°

CHAPTER 9-2

PROOFS

322. In the accompanying diagram of $ABCD$, where $a \neq b$, prove $ABCD$ is an isosceles trapezoid.

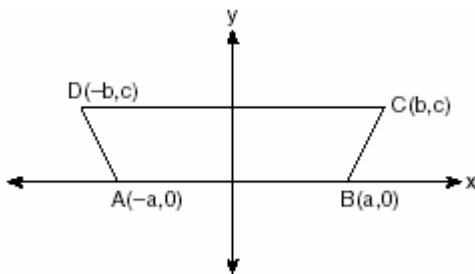

323. Prove that the diagonals of a parallelogram bisect each other.

CHAPTER 9-3

SPECIAL QUADRILATERALS

324. Which quadrilateral must have diagonals that are congruent and perpendicular?
[A] rhombus [B] square
[C] trapezoid [D] parallelogram
325. In rectangle $ABCD$, $AC = 3x + 15$ and $BD = 4x - 5$. Find the length of \overline{AC} .
326. In the accompanying diagram of rectangle $ABCD$, $m\angle BAC = 3x + 4$ and $m\angle ACD = x + 28$.

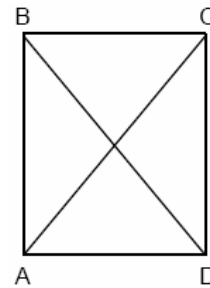

What is $m\angle CAD$?

- [A] 50 [B] 40 [C] 12 [D] 37

CHAPTER 9-6

PROOFS

327. Ashanti is surveying for a new parking lot shaped like a parallelogram. She knows that three of the vertices of parallelogram $ABCD$ are $A(0,0)$, $B(5,2)$, and $C(6,5)$. Find the coordinates of point D and sketch parallelogram $ABCD$ on the accompanying set of axes. Justify mathematically that the figure you have drawn is a parallelogram.

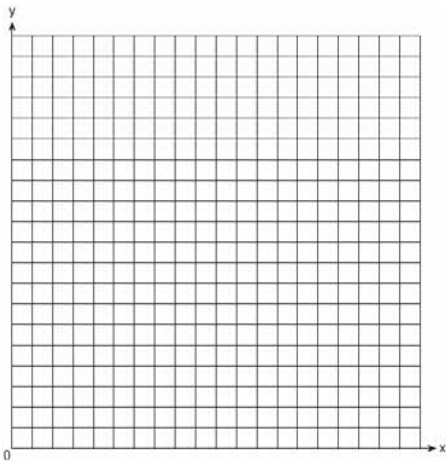

328. Given: quadrilateral $ABCD$ with vertices $A(-2,2)$, $B(8,-4)$, $C(6,-10)$, and $D(-4,-4)$. State the coordinates of $A'B'C'D'$, the image of quadrilateral $ABCD$ under a dilation of factor $\frac{1}{2}$. Prove that $A'B'C'D'$ is a parallelogram. [The use of the grid is optional.]

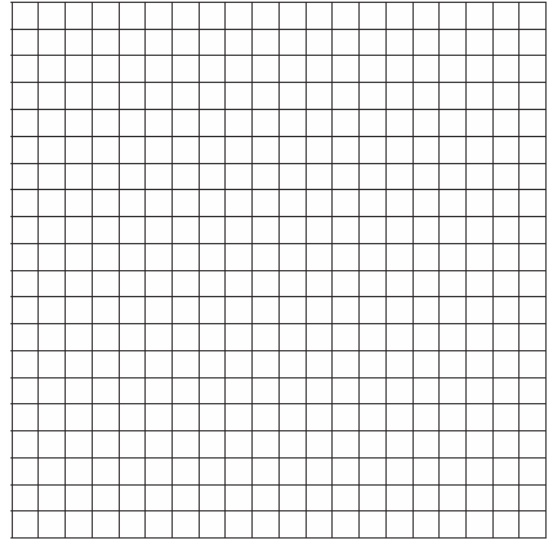

329. Given: $A(-2,2)$, $B(6,5)$, $C(4,0)$, $D(-4,-3)$
Prove: $ABCD$ is a parallelogram but not a rectangle. [The use of the grid is optional.]

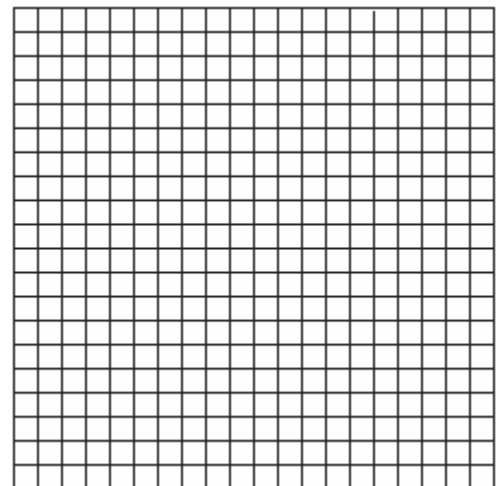

330. The coordinates of quadrilateral $ABCD$ are $A(-1,-5)$, $B(8,2)$, $C(11,13)$, and $D(2,6)$. Using coordinate geometry, prove that quadrilateral $ABCD$ is a rhombus. [The use of the grid is optional.]

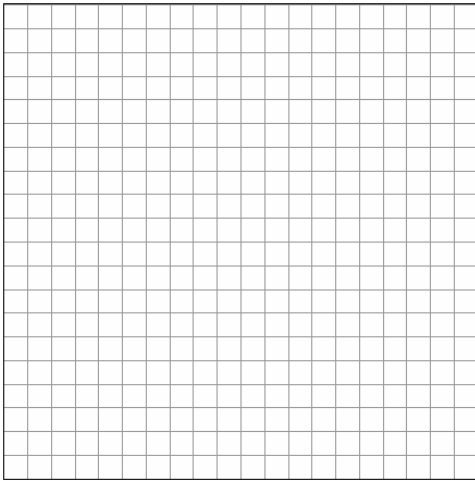

331. Jim is experimenting with a new drawing program on his computer. He created quadrilateral $TEAM$ with coordinates $T(-2,3)$, $E(-5,-4)$, $A(2,-1)$, and $M(5,6)$. Jim believes that he has created a rhombus but not a square. Prove that Jim is correct. [The use of the grid is optional.]

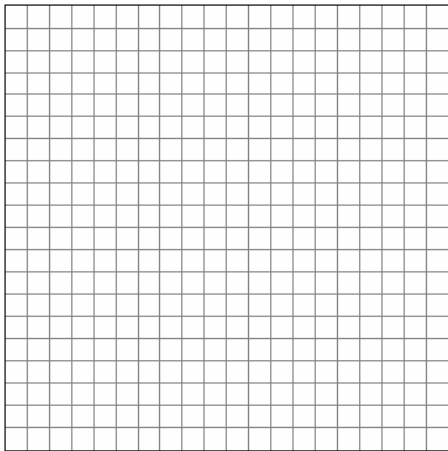

332. Given: $A(1,6)$, $B(7,9)$, $C(13,6)$, and $D(3,1)$
Prove: $ABCD$ is a trapezoid. [The use of the accompanying grid is optional.]

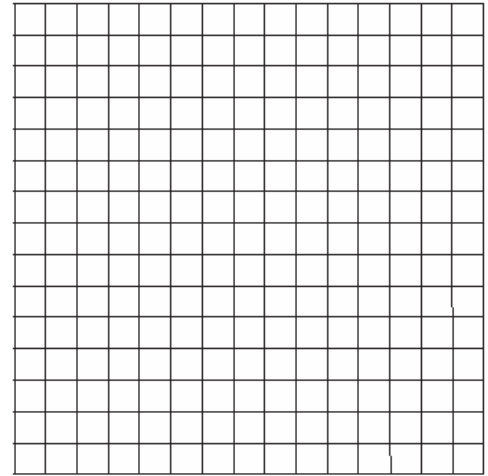

333. Quadrilateral $KATE$ has vertices $K(1,5)$, $A(4,7)$, $T(7,3)$, and $E(1,-1)$.
a Prove that $KATE$ is a trapezoid. [The use of the grid is optional.]
b Prove that $KATE$ is *not* an isosceles trapezoid.

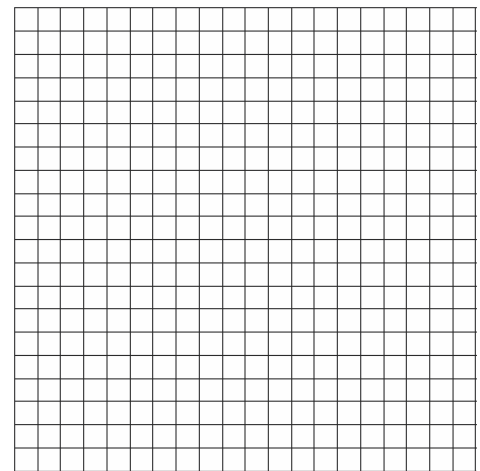

334. The coordinates of quadrilateral $JKLM$ are $J(1,-2)$, $K(13,4)$, $L(6,8)$, and $M(-2,4)$. Prove that quadrilateral $JKLM$ is a trapezoid but not an isosceles trapezoid. [The use of the grid is optional.]

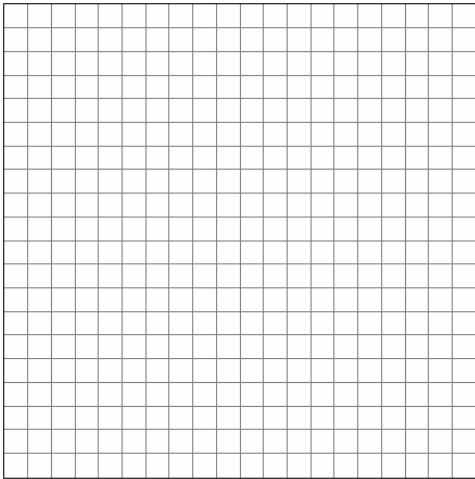

336. The Rivera family bought a new tent for camping. Their old tent had equal sides of 10 feet and a floor width of 15 feet, as shown in the accompanying diagram.

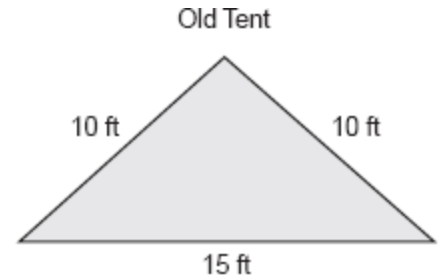

If the new tent is similar in shape to the old tent and has equal sides of 16 feet, how wide is the floor of the new tent?

337. A triangle has sides whose lengths are 5, 12, and 13. A similar triangle could have sides with lengths of

- [A] 6, 8, and 10 [B] 7, 24, and 25
[C] 10, 24, and 26 [D] 3, 4, and 15

CHAPTER 10-1

SIMILARITY

335. The accompanying diagram shows two similar triangles.



Which proportion could be used to solve for x ?

- [A] $\frac{32}{12} = \frac{15}{x}$ [B] $\frac{32}{x} = \frac{12}{15}$
[C] $\frac{x}{24} = \frac{9}{15}$ [D] $\frac{24}{9} = \frac{15}{x}$

338. The accompanying diagram shows a section of the city of Tacoma. High Road, State Street, and Main Street are parallel and 5 miles apart. Ridge Road is perpendicular to the three parallel streets. The distance between the intersection of Ridge Road and State Street and where the railroad tracks cross State Street is 12 miles. What is the distance between the intersection of Ridge Road and Main Street and where the railroad tracks cross Main Street?

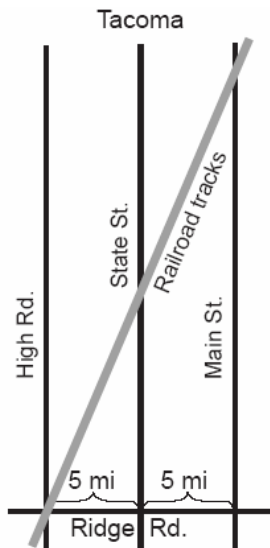

339. Fran's favorite photograph has a length of 6 inches and a width of 4 inches. She wants to have it made into a poster with dimensions that are similar to those of the photograph. She determined that the poster should have a length of 24 inches. How many inches wide will the poster be?

CHAPTER 10-3

340. The accompanying diagram shows a 24-foot ladder leaning against a building. A steel brace extends from the ladder to the point where the building meets the ground. The brace forms a right angle with the ladder. The brace forms a right angle with the ladder.

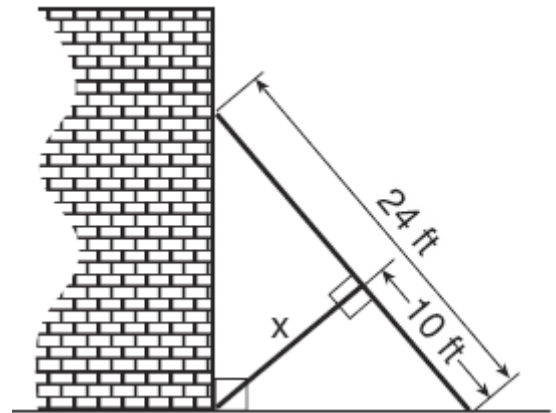

If the steel brace is connected to the ladder at a point that is 10 feet from the foot of the ladder, which equation can be used to find the length, x , of the steel brace?

- [A] $\frac{10}{x} = \frac{x}{24}$ [B] $10^2 + x^2 = 14^2$
 [C] $10^2 + x^2 = 24^2$ [D] $\frac{10}{x} = \frac{x}{14}$

CHAPTER 10-5

341. The perimeter of $\triangle A'B'C'$, the image of $\triangle ABC$, is twice as large as the perimeter of $\triangle ABC$. What type of transformation has taken place?
- [A] rotation [B] translation
 [C] reflection [D] dilation

342. Delroy's sailboat has two sails that are similar triangles. The larger sail has sides of 10 feet, 24 feet, and 26 feet. If the shortest side of the smaller sail measures 6 feet, what is the perimeter of the *smaller* sail?

- [A] 15 ft [B] 100 ft
[C] 36 ft [D] 60 ft

343. Two triangles are similar. The lengths of the sides of the smaller triangle are 3, 5, and 6, and the length of the longest side of the larger triangle is 18. What is the perimeter of the larger triangle?

- [A] 18 [B] 14 [C] 24 [D] 42

344. The base of an isosceles triangle is 5 and its perimeter is 11. The base of a similar isosceles triangle is 10. What is the perimeter of the larger triangle?

- [A] 22 [B] 15 [C] 110 [D] 21

345. On a scale drawing of a new school playground, a triangular area has sides with lengths of 8 centimeters, 15 centimeters, and 17 centimeters. If the triangular area located on the playground has a perimeter of 120 meters, what is the length of its longest side?

- [A] 45 m [B] 40 m
[C] 24 m [D] 51 m

346. In the accompanying diagram of equilateral triangle ABC , $DE = 5$ and $\overline{DE} \parallel \overline{AB}$.

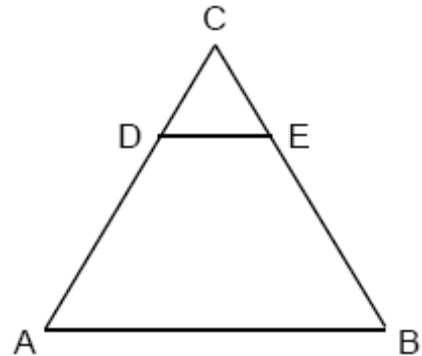

If AB is three times as long as DE , what is the perimeter of quadrilateral $ABED$?

- [A] 40 [B] 35 [C] 30 [D] 20

347. The lengths of the sides of two similar rectangular billboards are in the ratio 5:4. If 250 square feet of material is needed to cover the larger billboard, how much material, in square feet, is needed to cover the smaller billboard?

348. The ratio of the corresponding sides of two similar squares is 1 to 3. What is the ratio of the area of the smaller square to the area of the larger square ?

- [A] 1:3 [B] 1:6 [C] $1:\sqrt{3}$ [D] 1:9

349. The perimeter of an equilateral triangle varies directly as the length of a side. When the length of a side is doubled, the perimeter of the triangle is

- [A] halved [B] divided by 3
[C] multiplied by 3 [D] doubled

350. If the circumference of a circle is doubled, the diameter of the circle

- [A] increases by 2 [B] is doubled
[C] remains the same
[D] is multiplied by 4

CHAPTER 11-5

VECTORS

351. Two tow trucks try to pull a car out of a ditch. One tow truck applies a force of 1,500 pounds while the other truck applies a force of 2,000 pounds. The resultant force is 3,000 pounds. Find the angle between the two applied forces, rounded to the *nearest degree*.
352. One force of 20 pounds and one force of 15 pounds act on a body at the same point so that the resultant force is 19 pounds. Find, to the *nearest degree*, the angle between the two original forces.
353. Two equal forces act on a body at an angle of 80° . If the resultant force is 100 newtons, find the value of one of the two equal forces, to the *nearest hundredth of a newton*.
354. A jet is flying at a speed of 526 miles per hour. The pilot encounters turbulence due to a 50-mile-per-hour wind blowing at an angle of 47° , as shown in the accompanying diagram.

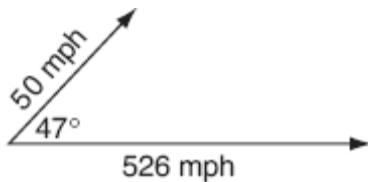

Find the resultant speed of the jet, to the *nearest tenth of a mile per hour*. Use this answer to find the measure of the angle between the resultant force and the wind vector, to the *nearest tenth of a degree*.

355. Two forces of 40 pounds and 20 pounds, respectively, act simultaneously on an object. The angle between the two forces is 40° . Find the magnitude of the resultant, to the *nearest tenth of a pound*. Find the measure of the angle, to the *nearest degree*, between the resultant and the larger force.

CHAPTER 11-6

USING TRIGONOMETRY TO FIND AREA

356. Jack is planting a triangular rose garden. The lengths of two sides of the plot are 8 feet and 12 feet, and the angle between them is 87° . Which expression could be used to find the area of this garden?
- [A] $\frac{1}{2} \cdot 8 \cdot 12 \cdot \sin 87^\circ$
- [B] $\frac{1}{2} \cdot 8 \cdot 12 \cdot \cos 87^\circ$
- [C] $8 \cdot 12 \cdot \cos 87^\circ$ [D] $8 \cdot 12 \cdot \sin 87^\circ$
357. The accompanying diagram shows the floor plan for a kitchen. The owners plan to carpet all of the kitchen except the "work space," which is represented by scalene triangle ABC . Find the area of this work space to the *nearest tenth of a square foot*.

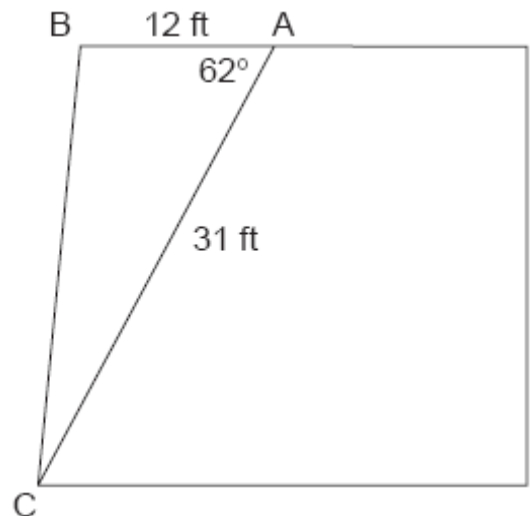

358. Two sides of a triangular-shaped pool measure 16 feet and 21 feet, and the included angle measures 58° . What is the area, to the *nearest tenth of a square foot*, of a nylon cover that would exactly cover the surface of the pool?
359. The triangular top of a table has two sides of 14 inches and 16 inches, and the angle between the sides is 30° . Find the area of the tabletop, in square inches.
360. A landscape architect is designing a triangular garden to fit in the corner of a lot. The corner of the lot forms an angle of 70° , and the sides of the garden including this angle are to be 11 feet and 13 feet, respectively. Find, to the *nearest integer*, the number of square feet in the area of the garden.
361. In $\triangle ABC$, $AC = 18$, $BC = 10$, and $\cos C = \frac{1}{2}$. Find the area of $\triangle ABC$ to the *nearest tenth of a square unit*.
362. The accompanying diagram shows a triangular plot of land that is part of Fran's garden. She needs to change the dimensions of this part of the garden, but she wants the area to stay the same. She increases the length of side AC to 22.5 feet. If angle A remains the same, by how many feet should side AB be *decreased* to make the area of the new triangular plot of land the same as the current one?

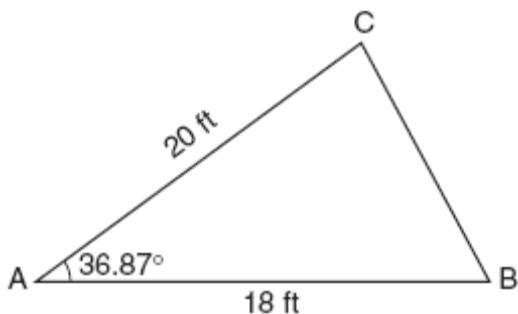

363. Gregory wants to build a garden in the shape of an isosceles triangle with one of the congruent sides equal to 12 yards. If the area of his garden will be 55 square yards, find, to the *nearest tenth of a degree*, the *three* angles of the triangle.

CHAPTER 12-1

GRAPHING CIRCLES

364. What is the greatest possible number of points of intersection of a triangle and a circle?
[A] 4 [B] 2 [C] 6 [D] 3
365. In a circle whose center is (2,3), one endpoint of a diameter is (-1,5). Find the coordinates of the other endpoint of that diameter. [The use of the accompanying grid is optional.]

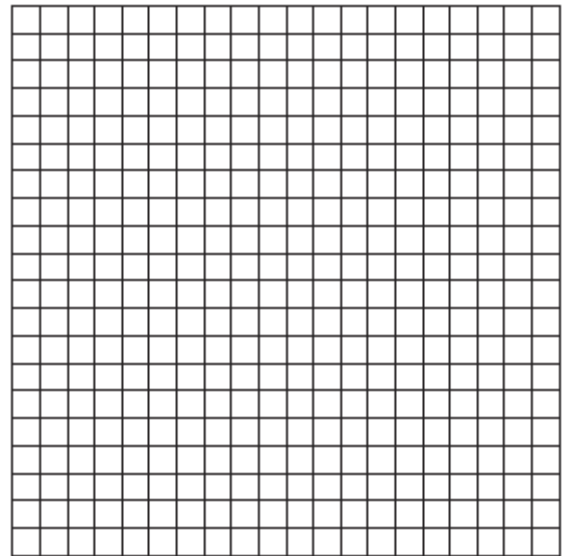

366. In the coordinate plane, the points (2,2) and (2,12) are the endpoints of a diameter of a circle. What is the length of the radius of the circle?
[A] 7 [B] 6 [C] 10 [D] 5

367. On the accompanying grid, graph a circle whose center is at (0,0) and whose radius is 5. Determine if the point (5,-2) lies on the circle.

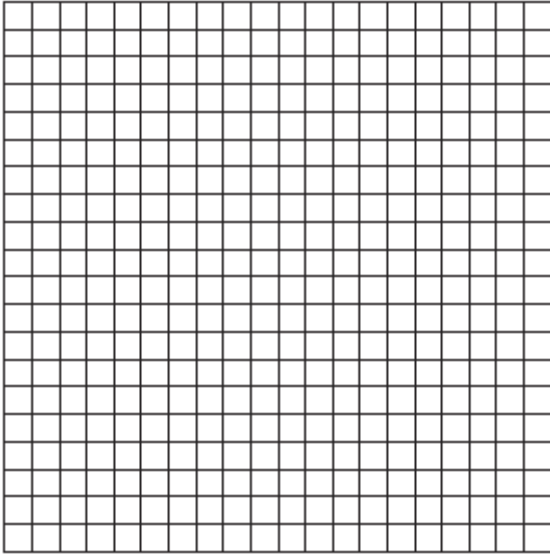

EQUATIONS OF CIRCLES

368. The graph of the equation $x^2 + y^2 = r^2$ forms
 [A] a parabola [B] a circle
 [C] two intersecting lines
 [D] a straight line

369. Which point is on the circle whose equation is $x^2 + y^2 = 289$?
 [A] (-12,12) [B] (-1,-16)
 [C] (7,-10) [D] (8,-15)

370. Which equation represents a circle whose center is (3, -2)?
 [A] $(x - 3)^2 + (y + 2)^2 = 4$
 [B] $(x - 2)^2 + (y + 3)^2 = 4$
 [C] $(x + 3)^2 + (y - 2)^2 = 4$
 [D] $(x + 2)^2 + (y - 3)^2 = 4$

371. Which equation represents the locus of points 4 units from the origin?

- [A] $x + y = 16$ [B] $x^2 + y^2 = 16$
 [C] $x^2 + y^2 = 4$ [D] $x = 4$

372. The graph of the equation $x^2 + y^2 = 4$ can be described as a

- [A] circle with its center at the origin and a radius of 4
 [B] line passing through points (0,2) and (2,0)
 [C] circle with its center at the origin and a radius of 2
 [D] parabola with its vertex at (0,2)

373. John uses the equation $x^2 + y^2 = 9$ to represent the shape of a garden on graph paper.

a Graph $x^2 + y^2 = 9$ on the accompanying grid.

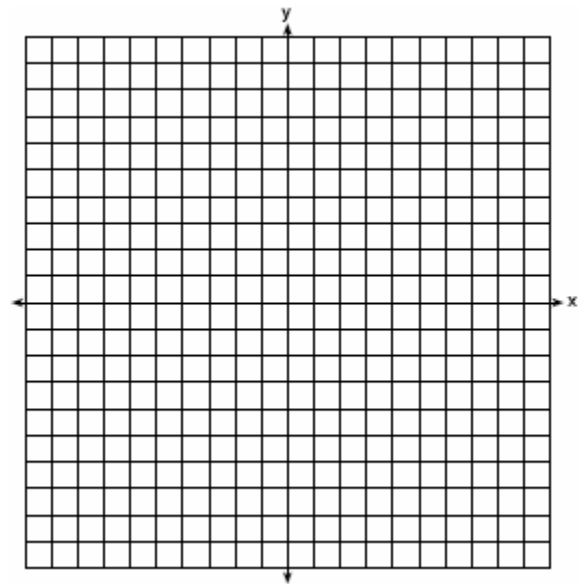

b What is the area of the garden to the nearest square unit?

CHAPTER 12-2

CHORDS SECANTS AND TANGENTS

374. Kimi wants to determine the radius of a circular pool without getting wet. She is located at point K , which is 4 feet from the pool and 12 feet from the point of tangency, as shown in the accompanying diagram.

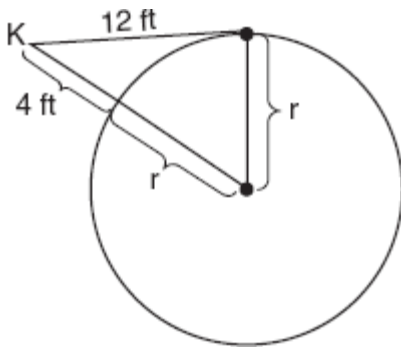

What is the radius of the pool?

- [A] 20 ft [B] $4\sqrt{10}$ ft
[C] 32 ft [D] 16 ft

CHAPTER 12-3

375. An overhead view of a revolving door is shown in the accompanying diagram. Each panel is 1.5 meters wide.

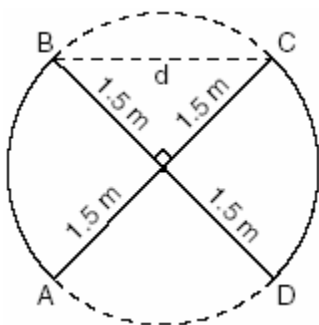

What is the approximate width of d , the opening from B to C ?

- [A] 1.50 m [B] 1.73 m
[C] 3.00 m [D] 2.12 m

376. The accompanying diagram shows a revolving door with three panels, each of which is 4 feet long. What is the width, w , of the opening between x and y , to the nearest tenth of a foot?

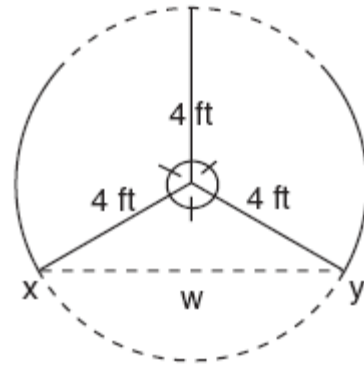

377. In the accompanying diagram of circle O , chords \overline{AB} and \overline{CD} intersect at E . If $AE = 3$, $EB = 4$, $CE = x$, and $ED = x - 4$, what is the value of x ?

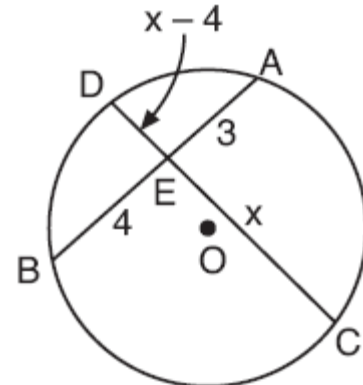

378. A toy truck is located within a circular play area. Alex and Dominic are sitting on opposite endpoints of a chord that contains the truck. Alex is 4 feet from the truck, and Dominic is 3 feet from the truck. Meira and Tamara are sitting on opposite endpoints of another chord containing the truck. Meira is 8 feet from the truck. How many feet, to the nearest tenth of a foot, is Tamara from the truck? Draw a diagram to support your answer.

379. In the accompanying diagram of circle O , chord \overline{AY} is parallel to diameter \overline{DOE} , \overline{AD} is drawn, and $m\widehat{AD} = 40$.

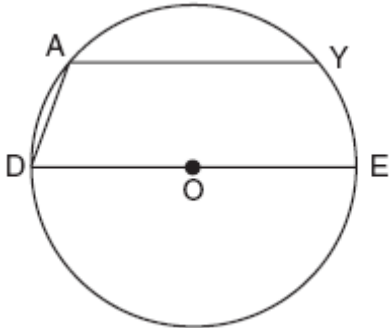

What is $m\angle DAY$?

- [A] 110 [B] 90 [C] 150 [D] 130

CHAPTER 12-4

PROOFS

380. In the accompanying diagram, $m\widehat{BR} = 70$, $m\widehat{YD} = 70$, and \overline{BOD} is the diameter of circle O . Write an explanation or a proof that shows $\triangle RBD$ and $\triangle YDB$ are congruent.

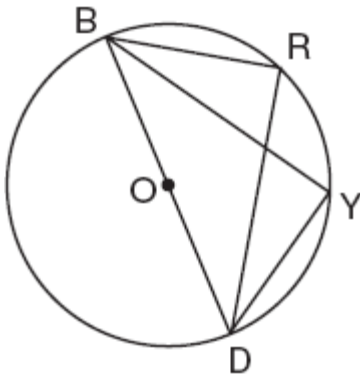

381. Given: chords \overline{AB} and \overline{CD} of circle O intersect at E , an interior point of circle O ; chords \overline{AD} and \overline{CB} are drawn.

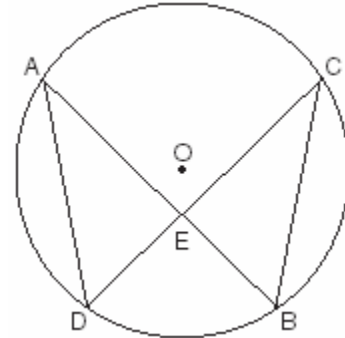

Prove: $(AE)(EB) = (CE)(ED)$

382. In the accompanying diagram of circle O , diameter \overline{AOB} is drawn, tangent \overline{CB} is drawn to the circle at B , E is a point on the circle, and $\overline{BE} \parallel \overline{ADC}$.

Prove: $\triangle ABE \cong \triangle CAB$

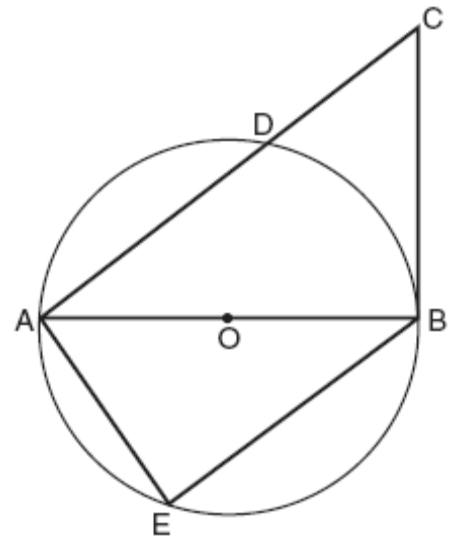

CHAPTER 12-6

383. A regular hexagon is inscribed in a circle. What is the ratio of the length of a side of the hexagon to the minor arc that it intercepts?

- [A] $\frac{6}{\pi}$ [B] $\frac{\pi}{6}$ [C] $\frac{3}{6}$ [D] $\frac{3}{\pi}$

384. The accompanying diagram represents circular pond O with docks located at points A and B . From a cabin located at C , two sightings are taken that determine an angle of 30° for tangents \overline{CA} and \overline{CB} .

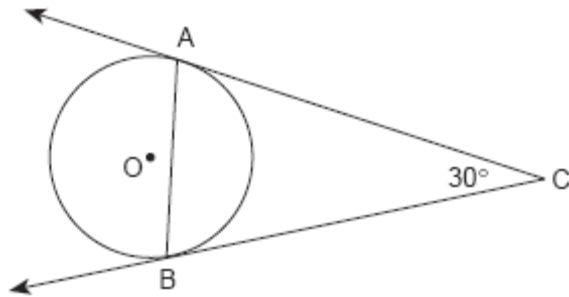

What is $m\angle CAB$?

- [A] 30 [B] 60 [C] 75 [D] 150

385. A small fragment of something brittle, such as pottery, is called a shard. The accompanying diagram represents the outline of a shard from a small round plate that was found at an archaeological dig.



If \overline{BC} is a tangent to \widehat{AC} at B and $m\angle ABC = 45$, what is the measure of \widehat{AC} , the outside edge of the shard?

- [A] 225° [B] 90° [C] 135° [D] 45°

386. The accompanying diagram shows a child's spin toy that is constructed from two chords intersecting in a circle. The curved edge of the larger shaded section is one-quarter of the circumference of the circle, and the curved edge of the smaller shaded section is one-fifth of the circumference of the circle.

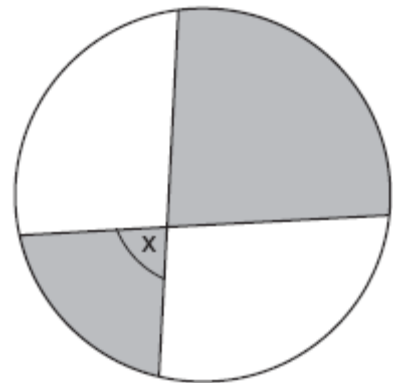

What is the measure of angle x ?

- [A] 108° [B] 72° [C] 40° [D] 81°

387. In the accompanying diagram, the length of \widehat{ABC} is $\frac{3\pi}{2}$ radians.

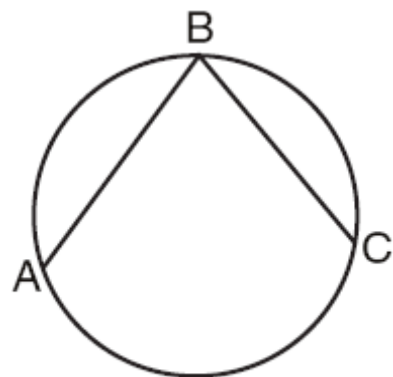

(Not drawn to scale)

What is $m\angle ABC$?

- [A] 45 [B] 36 [C] 53 [D] 72

388. The new corporate logo created by the design engineers at Magic Motors is shown in the accompanying diagram.

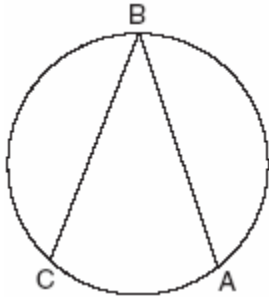

If chords \overline{BA} and \overline{BC} are congruent and $m\widehat{BC} = 140$, what is $m\angle B$?

- [A] 40 [B] 140 [C] 80 [D] 280

389. A machine part consists of a circular wheel with an inscribed triangular plate, as shown in the accompanying diagram. If $\overline{SE} \cong \overline{EA}$, $SE = 10$, and $m\widehat{SE} = 140$, find the length of \overline{SA} to the nearest tenth.

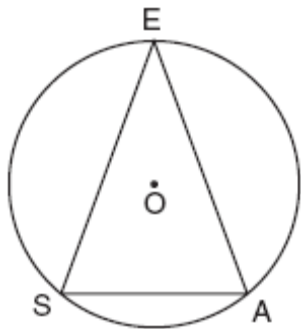

390. In the accompanying diagram of circle O , diameter \overline{AOB} is extended through B to external point P , tangent \overline{PC} is drawn to point C on the circle, and $m\widehat{AC} : m\widehat{BC} = 7 : 2$. Find $m\angle CPA$.

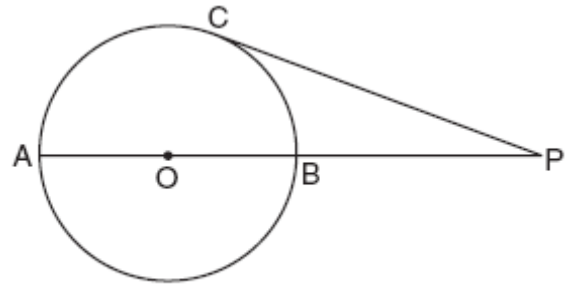

(Not drawn to scale)

391. Point P lies outside circle O , which has a diameter of \overline{AOC} . The angle formed by tangent \overline{PA} and secant \overline{PBC} measures 30° . Sketch the conditions given above and find the number of degrees in the measure of minor arc CB .

392. In the accompanying diagram, cabins B and G are located on the shore of a circular lake, and cabin L is located near the lake. Point D is a dock on the lake shore and is collinear with cabins B and L . The road between cabins G and L is 8 miles long and is tangent to the lake. The path between cabin L and dock D is 4 miles long.

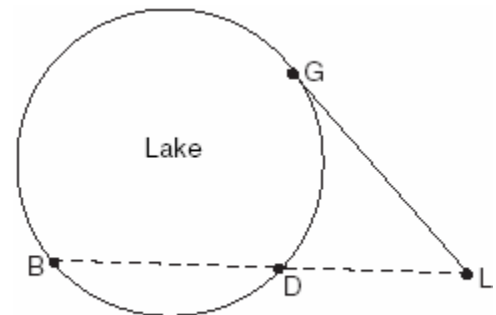

(Not drawn to scale)

What is the length, in miles, of \overline{BD} ?

- [A] 24 [B] 12 [C] 8 [D] 4

393. The accompanying diagram shows a circular machine part that has rods \overline{PT} and \overline{PAR} attached at points T , A , and R , which are located on the circle;
 $m\widehat{TA} : m\widehat{AR} : m\widehat{RT} = 1 : 3 : 5$; $RA = 12$ centimeters; and $PA = 5$ centimeters.

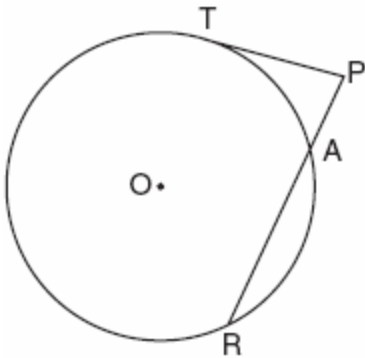

Find the measure of $\angle P$, in degrees, and find the length of rod \overline{PT} , to the nearest tenth of a centimeter.

394. In the accompanying diagram, \overline{PA} is tangent to circle O at A , secant \overline{PBC} is drawn, $PB = 4$, and $BC = 12$. Find PA .

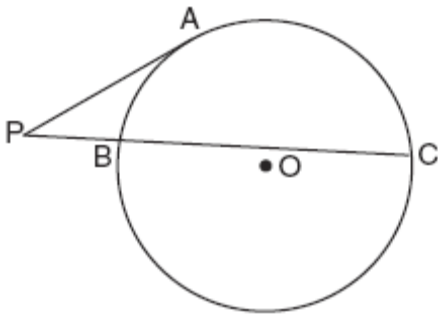

395. An architect is designing a park with an entrance represented by point C and a circular garden with center O , as shown in the accompanying diagram. The architect plans to connect three points on the circumference of the garden, A , B , and D , to the park entrance, C , with walkways so that walkways \overline{CA} and \overline{CB} are tangent to the garden, walkway \overline{DOEC} is a path through the center of the garden, $m\widehat{ADB} : m\widehat{AEB} = 3 : 2$, $BC = 60$ meters, and $EC = 43.6$ meters. Find the measure of the angle between walkways \overline{CA} and \overline{CB} . Find the diameter of the circular garden, to the nearest meter.

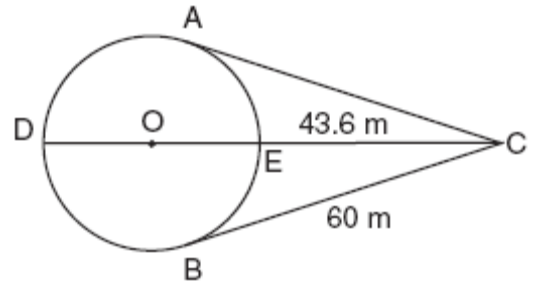

396. Given circle O with diameter \overline{GOAL} ; secants \overline{HUG} and \overline{HTAM} intersect at point H ; $m\widehat{GM} : m\widehat{ML} : m\widehat{LT} = 7 : 3 : 2$; and chord $\overline{GU} \cong$ chord \overline{UT} . Find the ratio of $m\angle UGL$ to $m\angle H$.

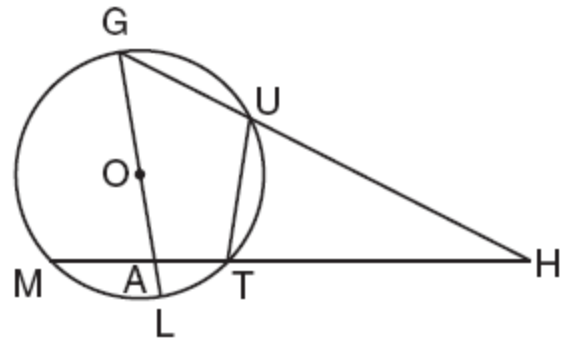

397. In the accompanying diagram, circle O has radius \overline{OD} , diameter \overline{BOHF} , secant \overline{CBA} , and chords \overline{DHG} and \overline{BD} ; \overline{CE} is tangent to circle O at D ; $m\widehat{DF} = 80$; and $m\widehat{BA} : m\widehat{AG} : m\widehat{GF} = 3 : 2 : 1$. Find $m\widehat{GF}$, and $m\angle BHD$, $m\angle BDG$, $m\angle GDE$, $m\angle C$, and $m\angle BOD$.

